



# Fast, Effective Impact Cleaning

## Alfa Laval TJ TZ-74 Self Cleaning Version Rotary Jet Head

### Application

The Toftejorg TZ-74 Self Cleaning Version rotary jet head provides 3D indexed impact cleaning over a defined time period. It is automatic and represents a guaranteed means of achieving quality assurance in tank cleaning. The device is suitable for processing, storage and transportation tanks and vessels between 50 and 500 m<sup>3</sup>. Used in breweries, food and dairy processes and many other industries with a strict demand for self cleaning of the machine and the downpipe. The Toftejorg TZ-74 Self Cleaning Version rotary jet head has been particularly successful in the brewing industry worldwide.

### Working principle

The flow of the cleaning fluid makes the nozzles perform a geared rotation around the vertical and horizontal axes. In the first cycle, the nozzles lay out a coarse pattern on the tank surface. The subsequent cycles gradually make the pattern more dense, until a full pattern is reached after 8 cycles.



### TECHNICAL DATA

Lubricant: . . . . . Self-lubricating with the cleaning fluid  
Standard Surface finish: . . . . . Ra 0.5µm exterior  
Max throw length: . . . . . 7 - 15 m  
Impact throw length: . . . . . 4 - 9 m

### Pressure

Working pressure: . . . . . 3 - 12 bar  
Recommended pressure: . . . . . 5 - 6.5 bar

### Cleaning Pattern

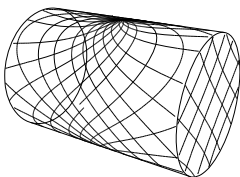

First cycle

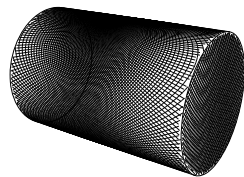

Full pattern

The above drawings show the cleaning pattern achieved on a cylindrical horizontal vessel. The difference between the first cycle and the full pattern represents the number of additional cycles available to increase the density of the cleaning.

### Certificates

2.1 material certificate and ATEX.

### PHYSICAL DATA

#### Materials

316L (UNS S31603), PTFE, PEEK, ETFE, TFM

#### Temperature

Max. working temperature: . . . . . 95°C  
Max. ambient temperature: . . . . . 140°C

#### Weight:

. . . . . 6.1 kg

#### Connections

Standard female thread: . . . . . 1 1/2" Rp (BSP) or NPT, 2" NPT

#### Options

Electronic rotation sensor to verify 3D coverage.

#### Caution

Do not use for gas evacuation or air dispersion.



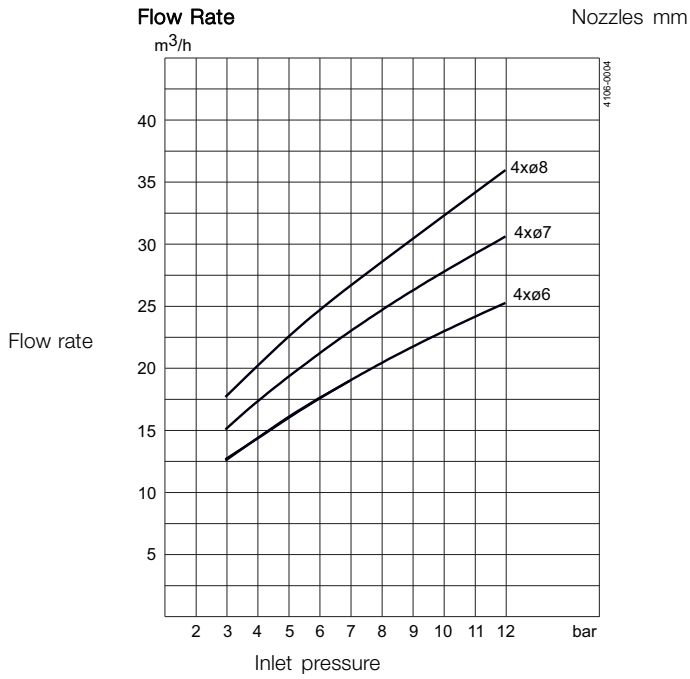

### Dimensions (mm)

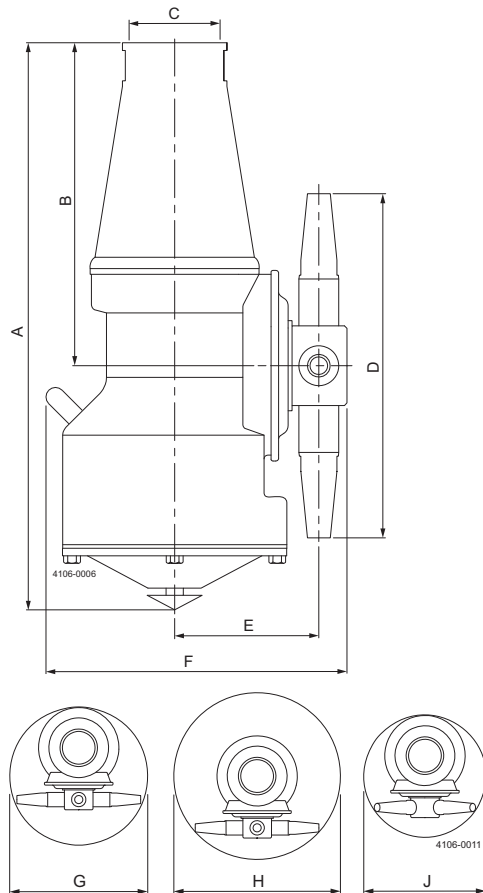

### Cleaning Time, Complete Pattern

Min. RPM of machine body

Nozzles mm

PTM (Pattern time minutes)

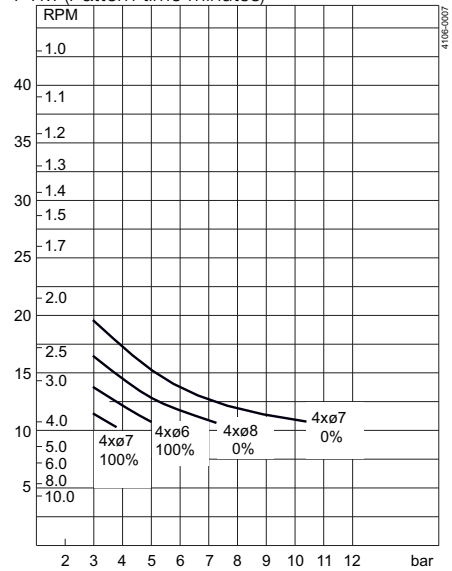

A	B	C	D	E	F	G	H	J
297	170	1½" BSP or 1 ½" / 2" NPT	204	78	152	ø225	ø264	ø190

### Standard Design

The choice of nozzle diameters can optimise jet impact length and flow rate at the desired pressure. As standard documentation, the Toftejorg TZ-74 Self Cleaning Version can be supplied with a "Declaration of Conformity" for material specifications.

### TRAX simulation tool

TRAX is a unique software that simulates how the Toftejorg TZ-74 Self Cleaning Version performs in a specific tank or vessel. The simulation gives information on wetting intensity, pattern mesh width and cleaning jet velocity. This information is used to determine the best location of the tank cleaning machine and the correct combination of flow, time and pressure to implement.

A TRAX demo containing different cleaning simulations covering a variety of applications can be used as reference and documentation for tank cleaning applications. A TRAX simulation is free and available upon request.

### Wetting Intensity

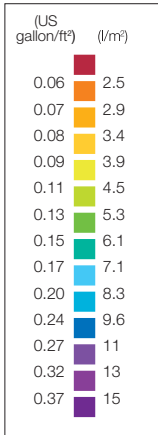

TD 523-208

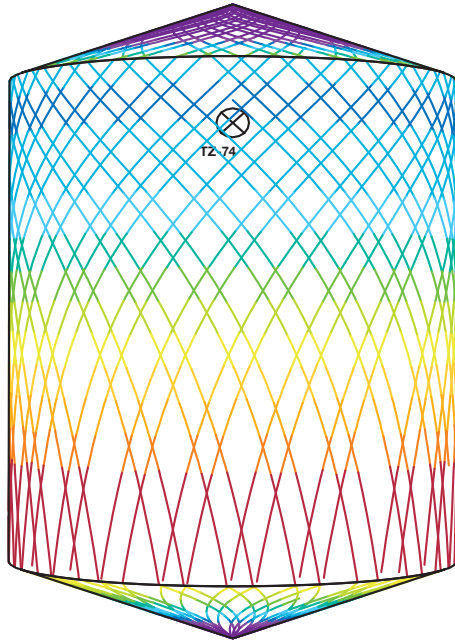

D5m H6m, Toftejorg TZ-74 Self Cleaning version, 4 x  $\varnothing 7$  mm, 0% Time = 3.8 min., Water consumption = 1192 l



D5m H6m, Toftejorg TZ-74 Self Cleaning version, 4 x  $\varnothing 7$  mm, 0% Time = 15.3 min., Water consumption = 4853 l

Alfa Laval reserves the right to change specifications without prior notification. ALFA LAVAL is a trademark registered and owned by Alfa Laval Corporate AB.

ESE00325EN 1507

© Alfa Laval



**CSI** 417.831.1411 • [csidesigns.com](http://csidesigns.com)