

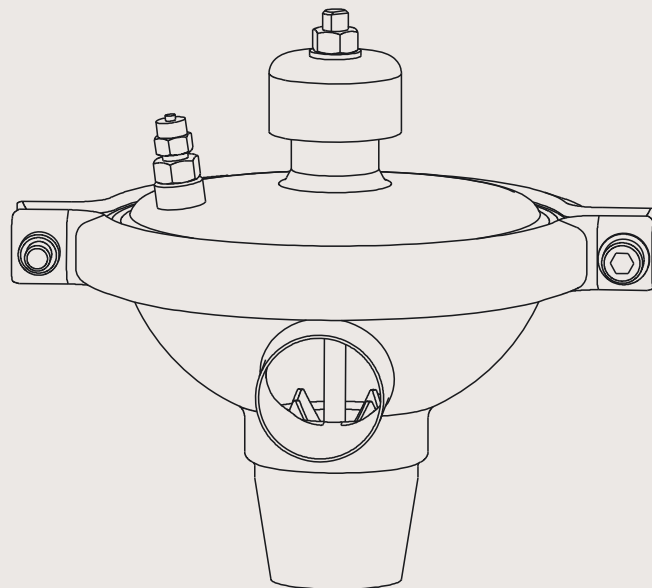

## Instruction Manual

### CPM-2 Constant-Pressure Modulating Valve



TD 417-121

# Declaration of Conformity

## The designating company

**Alfa Laval**

Company Name

**6000 Kolding**

Address

**+45 79 32 22 00**

Phone No.

hereby declare that

**Constant-Pressure Modulating Valve**

Denomination

**CPM-2**

Type

Year

is in conformity with the following directives:

- Machinery Directive 2006/42/EC

**Bjarne Søndergaard**

Name

**Manager, Product Centres,  
Compact Heat Exchangers & Fluid Handling**

Title

**Alfa Laval**

Company

*B. Søndergaard*

Signature

## Designation



---

*The information contained herein is correct at the time of issue but may be subject to change without prior notice.*

<b>1. Safety .....</b>	<b>6</b>
1.1 Important information .....	6
1.2 Warning signs .....	6
1.3 Safety precautions .....	6
<b>2. Installation .....</b>	<b>7</b>
2.1 Unpacking/Delivery .....	7
2.2 General installation .....	8
2.3 Welding .....	9
2.4 Fitting of Booster (optional extra) .....	10
<b>3. Operation .....</b>	<b>12</b>
3.1 Operation .....	12
3.2 Fault finding .....	13
3.3 Recommended cleaning .....	14
<b>4. Maintenance .....</b>	<b>15</b>
4.1 General maintenance .....	15
4.2 Dismantling .....	16
4.3 Assembly .....	18
<b>5. Technical Data .....</b>	<b>20</b>
5.1 Technical Data .....	20
5.2 Selection / Pressure drop - capacity diagram .....	21
<b>6. Parts lists and service kits .....</b>	<b>22</b>
6.1 CPM-2 .....	22
6.2 Booster .....	24

**1.1 Important information****1.2 Warning signs****1.3 Safety precautions**

*Unsafe practices and other important information are emphasized in this manual.*

*Warnings are emphasized by means of special signs.*

*All warnings in the manual are summarized on this page.*

*Pay special attention to the instructions below so that severe personal injury or damage to the valve are avoided.*

**Important information**

**Always read the manual before using the valve!**

**WARNING!** Indicates that special procedures **must** be followed to avoid severe personal injury.

**CAUTION!** Indicates that special procedures **must** be followed to avoid damage to the valve.

**NOTE!** Indicates important information to simplify or clarify practices.

**Warning signs**

General warning:



Caustic agents:

**Safety precautions****Installation:**

- **Always** observe the technical data (see chapter 5).
- **Always** release compressed air after use.
- **Never** touch the valve top if compressed air is supplied to the valve.
- The valve and the pipelines must never be pressurised when dismantling the valve.

**Operation:**

- **Always** observe the technical data (see chapter 5).
- **Always** release compressed air after use.
- **Never** touch the valve or the pipelines when processing hot liquids or when sterilizing.
- **Never** touch the valve top if compressed air is supplied to the valve.



**Always** handle lye and acid with great care.

**Maintenance:**

- **Always** observe the technical data (see chapter 5).
- **Always** disconnect compressed air before service.
- The valve must **never** be hot when servicing it.
- The valve and the pipelines must **never** be pressurised when servicing the valve.

**Transportation:**

**Always** secure that compressed air is released

**Always** secure that all connections is disconnected before attempt to remove the valve from the installation

**Always** drain liquid out of valves before transportation

**Always** used predesigned lifting points if defined

**Always** secure sufficient fixing of the valve during transportation - if special designed packaging material is available it must be used

The instruction manual is part of the delivery.  
 Study the instructions carefully.  
 CPMI-2: Constant-Pressure Modulating Inlet.  
 CPMO-2: Constant-Pressure Modulating Outlet.

**Step 1****NOTE!**

Alfa Laval cannot be held responsible for incorrect unpacking.

**Step 2****Check the delivery:**

1. Complete valve, CPMI-2 or CPMO-2.
2. Delivery note.
3. Instruction manual.

**Step 3**

Clean the valve ports for possible packing materials.  
 Avoid damaging the air connection and the valve ports.

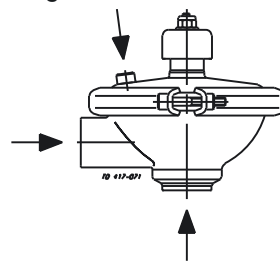
**Remove packing materials!****Step 4**

Inspect the valve for visible transport damages.

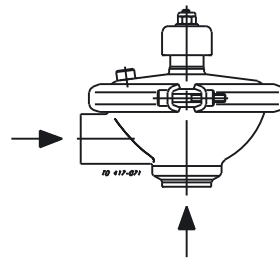
**Recycling information.****• Unpacking**

- Packing material consists of wood, plastics, cardboard boxes and in some cases metal straps.
- Wood and cardboard boxes can be reused, recycled or used for energy recovery.
- Plastics should be recycled or burnt at a licensed waste incineration plant.
- Metal straps should be sent for material recycling.

**• Maintenance**

- During maintenance oil and wear parts in the machine are replaced.
- All metal parts should be sent for material recycling.
- Worn out or defective electronic parts should be sent to a licensed handler for material recycling.
- Oil and all non metal wear parts must be taken care of in agreement with local regulations.

**• Scrapping**

- At end of use, the equipment shall be recycled according to relevant, local regulations. Beside the equipment itself, any hazardous residues from the process liquid must be considered and dealt with in a proper manner. When in doubt, or in the absence of local regulations, please contact the local Alfa Laval sales company.

Study the instructions carefully and pay special attention to the warnings!  
 The valve has welding ends as standard but can also be supplied with fittings.  
 CPMI-2: Constant-Pressure Modulating Inlet. CPMO-2: Constant-Pressure Modulating Outlet.  
 The required product pressure is preset by means of an air pressure regulating valve (optional extra).

**Step 1**



- **Always** observe the technical data (see chapter 5)
- **Always** release compressed air after use.
- **Never** touch the valve top if compressed air is supplied to the valve.

**NOTE!**

Alfa Laval cannot be held responsible for incorrect installation.

**Step 2**

Ensure that the flow direction is correct.

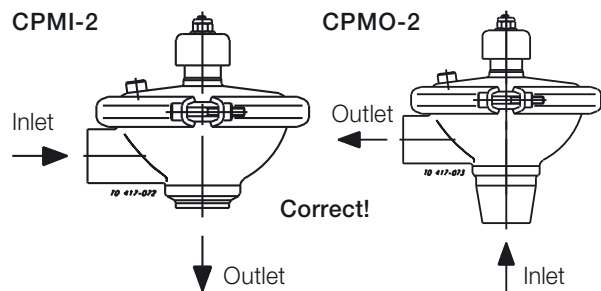

**Step 3**

Avoid stressing the valve.

Pay special attention to:

- Vibrations.
- Thermal expansion of the tubes.
- Excessive welding.
- Overloading of the pipelines.

Risk of damage!

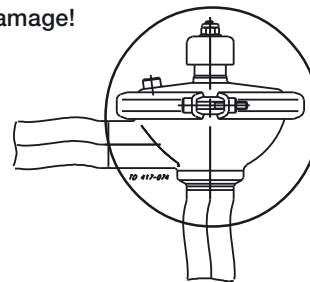

**Step 4**

**Fittings:**

Ensure that the connections are tight.

Remember seal rings!

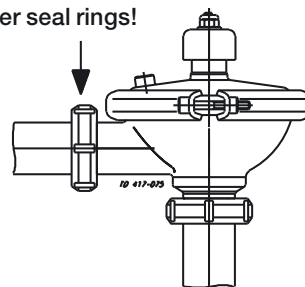

**Step 5**

**Air connection:**

R1/4 " (BSP)

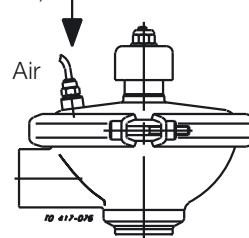

**Step 6**

**Air pressure regulating valve:** (optional extra)

An air pressure regulating valve must be used and should be installed with min. clearance to the Booster/CPM-2 valve.

Pressure regulating valve

As close as possible!

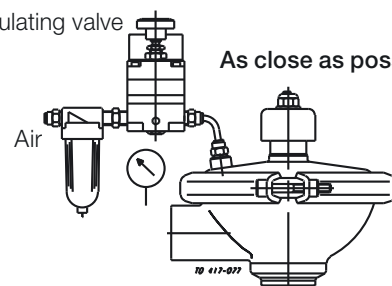

Study the instructions carefully.  
 The valve has welding ends as standard. Weld carefully.  
 CPMI-2: Constant-Pressure Modulating Inlet.  
 CPMO-2: Constant-Pressure Modulating Outlet.

**Step 1**

Dismantle the valve in accordance with steps 1-4 in section 4.2.

**Pay special attention to the warning!**

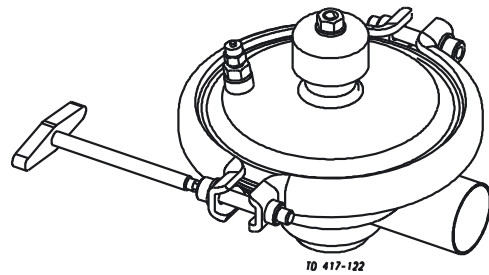

**Step 2**

**CPMI-2:**

1. Weld the valve body into the pipelines.
2. Maintain the minimum clearance so that the internal valve parts can be removed.

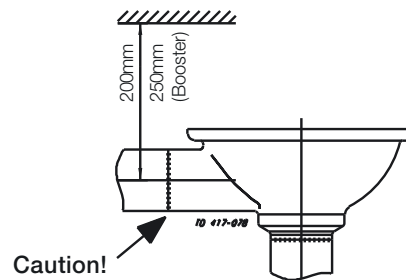

**Step 3**

**CPMO-2:**

1. Weld the valve body into the pipelines (see also step 4).
2. Maintain the minimum clearance so that the valve plug can be removed.

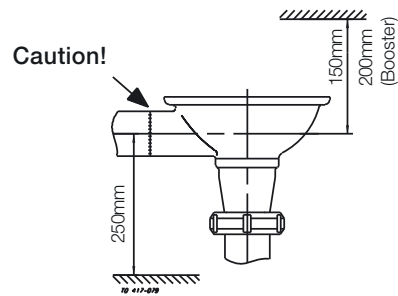

**Step 4**

**CPMO-2:**

Never weld the bottom connection as this will make it impossible to dismantle the valve.

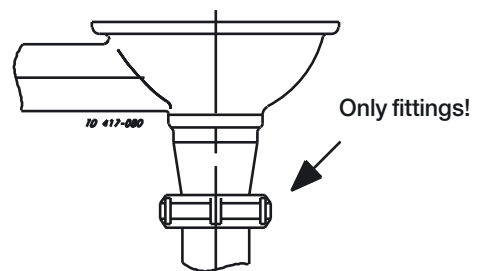

**Step 5**

Assemble the valve in accordance with the steps 6-10 in section 4.3.

Tighten clamp 10-15 Nm (7.5-11 lbf-ft)

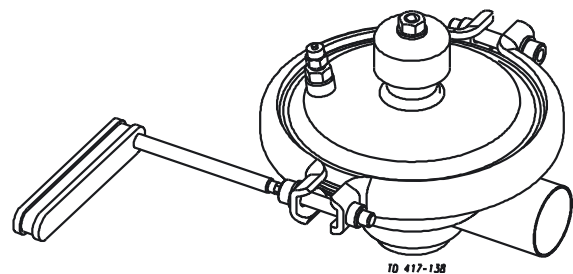

**Step 6**

**Pre-use check:**

Lift and lower the valve top several times to ensure that the valve operates smoothly.

**Pay special attention to the warning!**

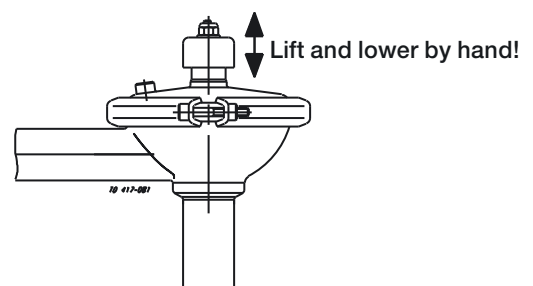

Study the instructions carefully and pay special attention to the warnings!

The items refer to the parts list and service kits section.

The valve can be fitted with a Booster to allow for a product pressure higher than available air pressure.

**Step 1**



- **Never** touch the valve or the pipelines when processing hot liquids or when sterilizing.
- The valve and the pipelines must **never** be pressurised when dismantling the valve.

Atmospheric pressure required!

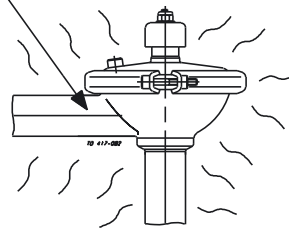

Burning danger!

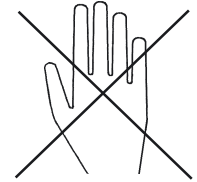

**Step 2**

1. Remove the valve top in accordance with step 3 in section 4.2

**Pay special attention to the warnings!**

2. Fit Booster housing (1) on the cover.
3. Fit and tighten lock nut (2).

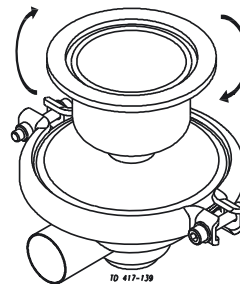

**Step 3**

1. Fit washer (3).
2. Refit the washer and the top nut on the valve plug.

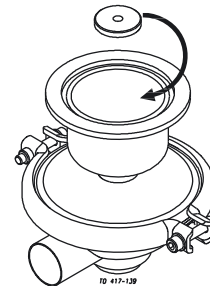

**Step 4**

1. Turn diaphragm (7) inside out.
2. Place piston (6) in the diaphragm so that the hole is visible.

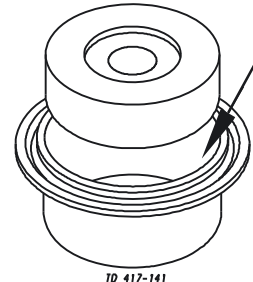

**Step 5**

1. Roll diaphragm (7) down half its length.
2. Fit the diaphragm with piston (6) in Booster housing (1).

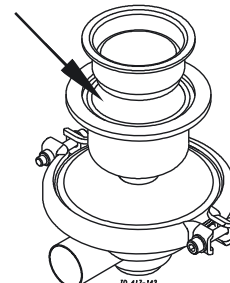

**Step 6**

1. Fit cover (8) on Booster housing (1).
2. Fit and tighten clamp (9).
3. The valve and the Booster are now ready for operation.

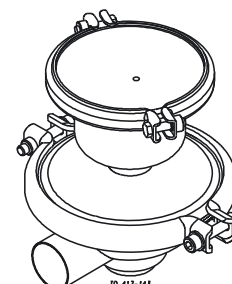



**Step 7**

**Compressed air:**

An air pressure compensating regulating valve must be used and should be installed with min. clearance to the Booster/CPM-2 valve.

The pressure regulating valve (PR) and the pressure gauge (PG) are optional extras.

Alfa Laval recommends using the air pressure regulating valve from Alfa Laval.

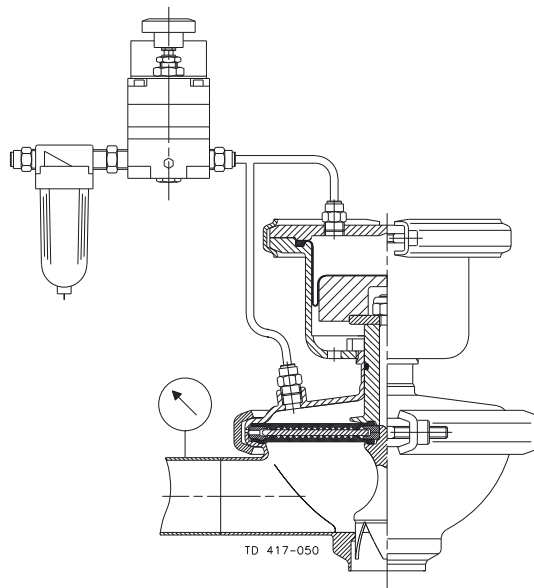

**Dimensions:**

ø164

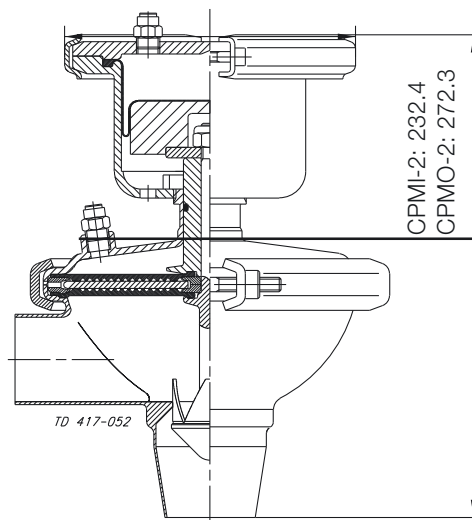

The valve is lubricated, adjusted and tested before delivery.  
 Study the instructions carefully and pay special attention to the warnings!  
 The items refer to the parts list and service kits section.

**Step 1**



- **Always** observe the technical data (see chapter 5)
- **Always** release compressed air after use.

**NOTE!**

Alfa Laval cannot be held responsible for incorrect installation.

**Step 2**



**Never** touch the valve or the pipelines when processing hot liquids or when sterilizing.

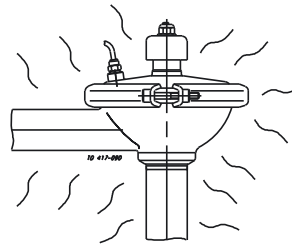

**Burning danger!**

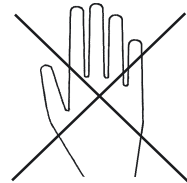

**Step 3**



**Never** touch the valve top if compressed air is supplied to the valve.

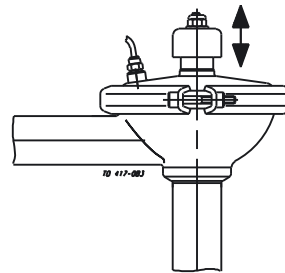

**Cutting danger!**

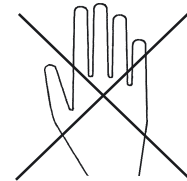

**Step 4**

**CAUTION!**

There must not be vacuum in the valve as air can be drawn into the product and diaphragms (14) can then be pulled out from support sectors (12).

**No vacuum!**

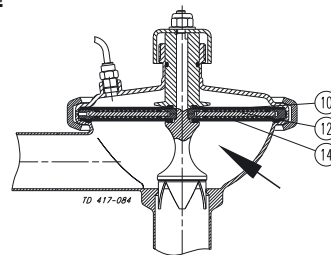

**Step 5**

**Lubrication:**

1. Ensure smooth movement between diaphragms (10,14) and support sectors (12).
2. Ensure smooth movement of guide (9).

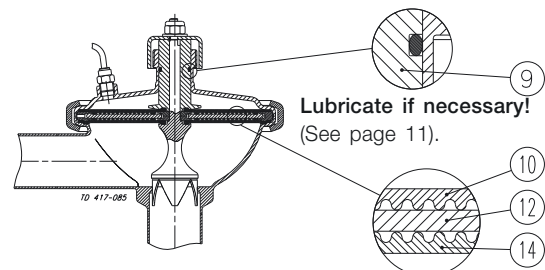

*Pay attention to possible break-down.*

*Study the instructions carefully.*

*The items refer to the parts list and service kits section.*

**NOTE!**

Study the maintenance instructions carefully before replacing worn parts - see section 4.1

Problem	Cause/result	Repair
The valve does not maintain the preset pressure	<ul style="list-style-type: none"> <li>- Faulty diaphragm</li> <li>- Guide (9) seizes</li> <li>- Incorrect operating range</li>   <li>- The available air pressure is lower than the product pressure</li> <li>- The air pressure is not correctly adjusted</li> <li>- Faulty air pressure regulating valve or incorrect type</li> </ul>	<ul style="list-style-type: none"> <li>- Replace the diaphragm</li> <li>- Lubricate the guide (see section 3.1)</li> <li>- Check the pressure drop over the valve and check the flow rate (see section 5.2)</li> <li>- Increase the air pressure eg. by using a Booster (see section 2.4).</li> <li>- Readjust the air pressure</li>   <li>- Repair the valve or check that it is pressure compensating</li> </ul>
Product leakage	<ul style="list-style-type: none"> <li>- Worn diaphragm</li> <li>- Product affected diaphragm</li> </ul>	Replace the diaphragm
Air leakage	<ul style="list-style-type: none"> <li>- Worn O-ring</li> <li>- Worn diaphragm (10)</li> <li>- Worn and hard diaphragm (10)</li> </ul>	<ul style="list-style-type: none"> <li>- Replace the O-ring</li> <li>- Replace the diaphragm</li> <li>- Replace by a diaphragm of a different grade for higher temperature (see section 5.1)</li> </ul>
Valve plug moving too fast up and down (unstable)	Pressure pulsations because of fast changes in process conditions	Use an air throttling valve (optional extra between the air pressure regulating valve and the CPM-2 valve.

The valve is designed for cleaning in place (CIP).

CIP = Cleaning In Place.

Study the instructions carefully and pay special attention to the warnings!

NaOH = Caustic Soda. HNO<sub>3</sub> = Nitric acid.

**Step 1**



**Always** handle lye and acid with great care.

**Caustic danger!**



**Always** use rubber gloves!



**Always** use protective goggles!

**Step 2**



**Never** touch the valve or the pipelines when sterilizing.

**Burning danger!**

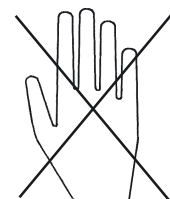
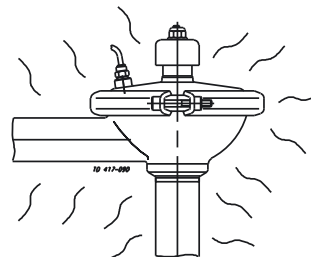

**Step 3**

Ensure that the valve is fully open to allow for maximum CIP flow.

**CPMI-2**

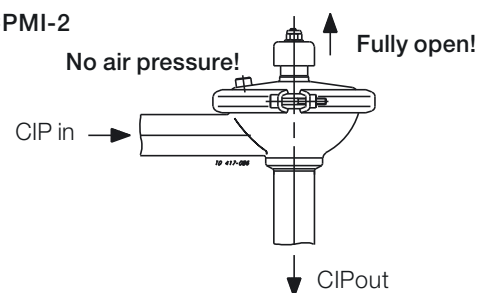

**Step 4**

**CPMO-2**

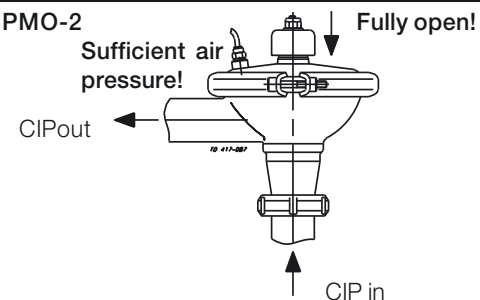

**Step 5**

**Examples of cleaning agents:**

Use clean water, free from chlorides.

1. 1% by weight NaOH at 70°C (158°F).

$$\boxed{1 \text{ kg (2.2 lb) NaOH}} + \boxed{100 \text{ l (26.4 gl) water}} = \text{Cleaning agent.}$$

2. 0.5% by weight HNO<sub>3</sub> at 70°C (158°F).

$$\boxed{0.7 \text{ l (0.2 gl) 53\% HNO}_3} + \boxed{100 \text{ l (26.4 gl) water}} = \text{Cleaning agent.}$$

$$\boxed{2.2 \text{ l (0.6 gl) 33\% NaOH}} + \boxed{100 \text{ l (26.4 gl) water}} = \text{Cleaning agent.}$$

**Step 6**

1. Avoid excessive concentration of the cleaning agent  
⇒ **Dose gradually!**
2. Adjust the cleaning flow to the process  
⇒ **Milk sterilization/viscous liquids**  
⇒ **Increase the cleaning flow!**
3. **Always** rinse well with clean water after the cleaning.

**NOTE!**

The cleaning agents must be stored/discharged in accordance with current rules/directives.

Maintain the valve carefully.  
 Study the instructions carefully and pay special attention to the warnings!  
 Always keep spare diaphragms and o-rings in stock.

**Step 1**



- **Always** observe the technical data (see chapter 5).
- **Always** disconnect the compressed air before service.

**NOTE!**

All scrap must be stored/discharged in accordance with current rules/directives.

**Step 2**



- The valve must **never** be hot when servicing it.
- The valve and the pipelines must **never** be pressurised when servicing the valve.

Atmospheric pressure required!

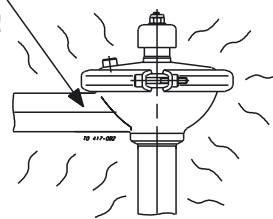

Burning danger!

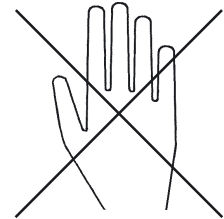

**Recommended spare parts:** Service kits (see chapter 6)  
 Order service kits from the service kits list (see chapter 6)  
**Ordering spare parts:** contact the Sales Department

	Diaphragms	O-ring
Preventive maintenance	<b>Replace after 12 months</b>	Replace when replacing the diaphragms
Maintenance after leakage (leakage normally starts slowly)	<b>Replace by the end of the day</b>	Replace when replacing the diaphragms
Planned maintenance	<ul style="list-style-type: none"> <li>- Regular inspection for leakage and smooth operation</li> <li>- Keep a record of the valve</li> <li>- Use the statistics for planning of inspections</li> </ul>	Replace when replacing the diaphragms
	<b>Replace after leakage</b>	

- Lubrication :** (Before assembly)
- Guide: Molycote longtherm 2 Plus.
  - Sectors: Molycote 111.
  - Threads: Molycote TP42.

Study the instructions carefully.

The items refer to the parts list and service kits section.

Handle scrap correctly.

CPMI-2: Constant-Pressure Modulating Inlet. CPMO-2: Constant-Pressure Modulating Outlet.

**Step 1**

Loosen and remove clamp (6).

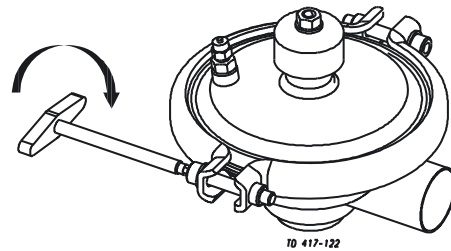

**Step 2**

**CPMI-2:**

Remove cover (7) together with the internal parts of the valve from valve body (16).

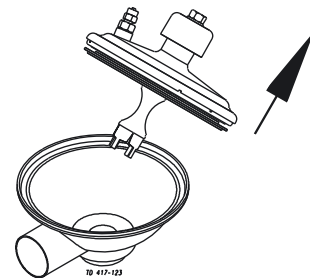

**Step 3**

**CPMI-2 and CPMO-2 valves:**

Remove top nut (1), washer (2) and top (3) from plug 15a or 15b).

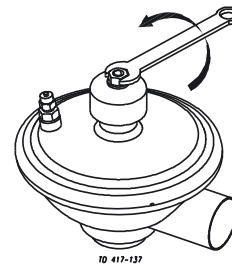

**Step 4**

Remove plug (15a) from the diaphragm unit and guide (9), or for **CPMO-2** remove plug (15b) from valve body (16) and remove cover (7) and the internal parts of the valve.

**CAUTION!**

Ensure that cover (7) is turned downwards and plug (15a) is pulled upwards so that sectors (12) are not separated from diaphragms (10, 14).

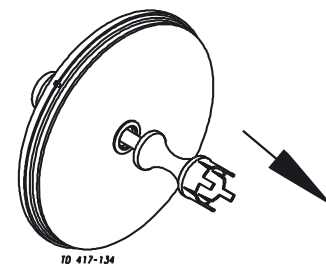

**Step 5**

Remove lower inner ring (11) and lower diaphragm (14).

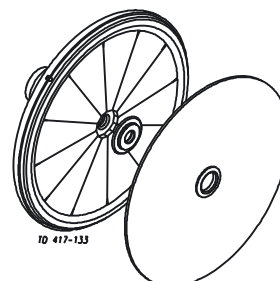

**Step 6**

Remove sectors (12).

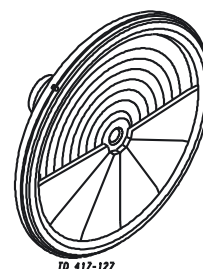

**Step 7**

Remove outer ring (13), upper inner ring (11) and upper diaphragm (10).

**Step 8**

Remove guide (9) from cover (7).

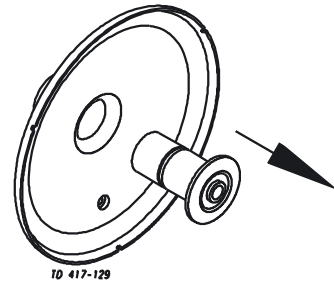
**Step 9**

Remove O-ring (8) from guide (9).

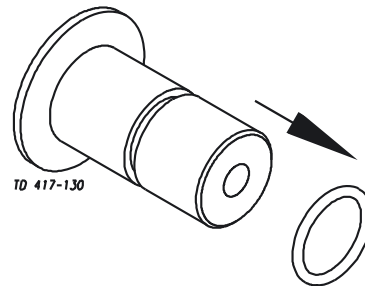
**Step 10**

Replace the O-ring and the diaphragms.

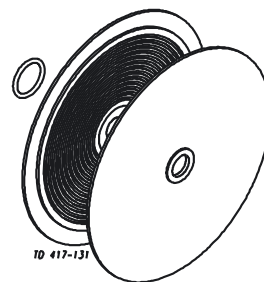

Study the instructions carefully.

The items refer to the parts list and service kits section.

Lubricate the guide, the sectors and the threads before assembly.

CPMI-2: Constant-Pressure Modulating Inlet. CPMO-2: Constant-Pressure Modulating Outlet.

**Step 1**

Fit O-ring (8)

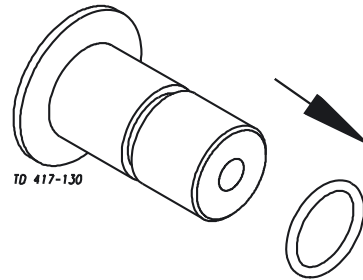

**Step 2**

Lubricate guide (9) and fit it into cover (7).

**NOTE!**

Turn cover (7) downwards before continuing.

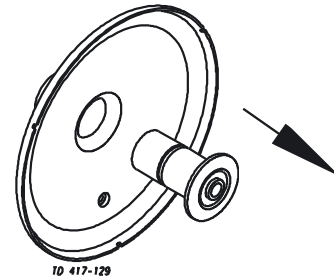

**Step 3**

Fit upper diaphragm (10), upper inner ring (11) and outer ring (13) on guide (9) and cover (7).

**NOTE!**

The upper diaphragm has a small recess. The outer ring must be fitted with the recess turned uppermost so that the indication hole is fixed opposite the indication hole in the cover.

Fit the correct diaphragm!

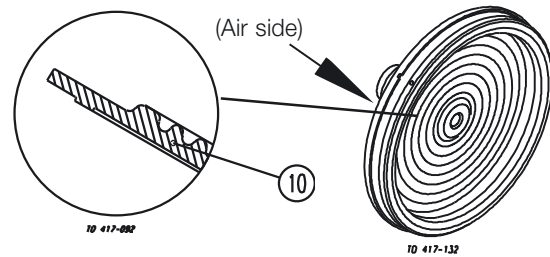

**Step 4**

Fit sectors (12) between upper inner ring (11) and outer ring (13).

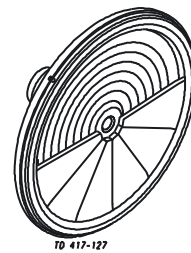

**Step 5**

Fit lower inner ring (11) and lower diaphragm (14). Concentric grooves should point towards the steel segments.

Fit the correct diaphragm!

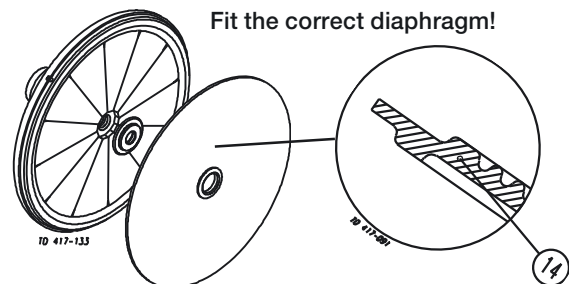

**Step 6**

**CPMI-2:**

Fit plug (15a) in the diaphragm unit and guide (9) until the flange of the plug contacts lower diaphragm (14).

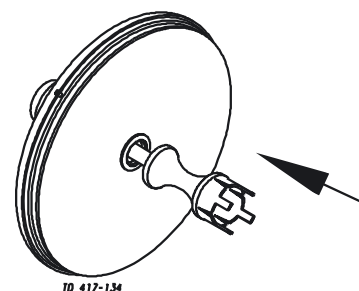



**Step 7**

Fit valve body (16) in cover (7).

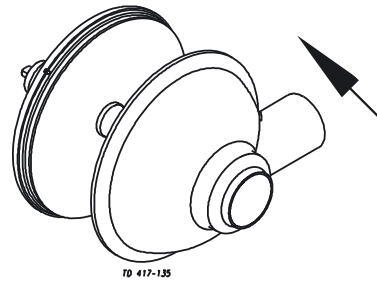

**Step 8**

**CPMO-2:**

Fit plug (15b) through valve body (16) and in the diaphragm unit and guide (9) until the flange of the plug contacts lower diaphragm (14).

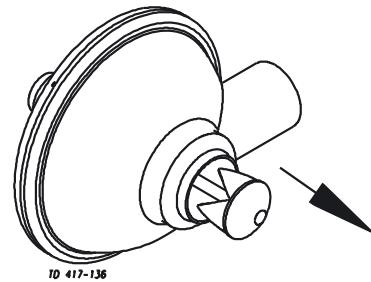

**Step 9**

Fit top (3), washer (2) and top nut (1) on plug (15a or 15b).

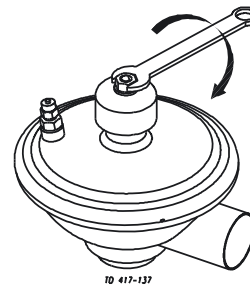

**Step 10**

Fit and torque tighten clamp (6) to 10-15Nm (7.5-11 lbf-ft).

10-15Nm (7.5-11 lbf-ft)

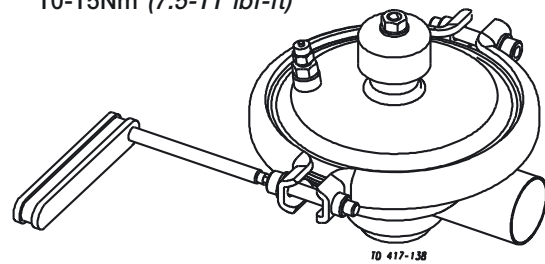

**Step 11**

**Pre-use check:**

Lift and lower the valve top several times to ensure that the valve operates smoothly.

**Pay special attention to the warning!**

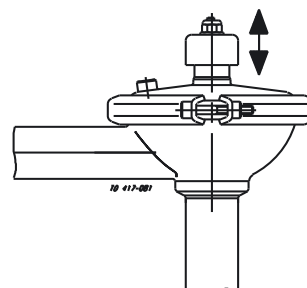

*It is important to observe the technical data during installation, operation and maintenance.  
Inform the personnel about the technical data.*

Data	
Max. product pressure	1000 kPa (10 bar) (145 psi)
Min. product pressure	No vacuum
Temperature range	-10°C to +95°C (14°F to 203°F)
Temperature range (with upper diaphragm in PTFE/EPDM)	-10°C to +140°C (14°F to 284°F) (higher on request)
Air pressure	0 to 600 kPa (0 to 6 bar) (0 to 87 psi)
Flow range Kv (Lv), fully open ( $\Delta p = 1\text{bar}$ ) (14.5 psi)	Approx. 23m <sup>3</sup> /h (101 gal/m)
Flow range Kv (Lv), low capacity ( $\Delta p = 1\text{bar}$ ) (14.5 psi) (Alternative size)	Approx. 2m <sup>3</sup> /h (8.8 gal/m) (regulating area) Approx. 15m <sup>3</sup> /h (66 gal/m) (CIP area)
Materials	
Product wetted steel parts	AISI 316 L
Other steel parts	AISI 304
Upper diaphragm	Nitrile (NBR), (standard)
Lower diaphragm	PTFE covered EPDM rubber, (standard)
Alternative upper diaphragm	EPDM/PTFE, (for temperatures 95-140° C) (203°F to 284°F)
Alternative upper diaphragm	Solid Teflon (PTFE), (for temperatures above 140° C) (284°F)
Alternative lower diaphragm	Solid Teflon (PTFE), (for temperatures above 140° C) (284°F)
Alternative O-ring	O-ring Nitrile (NBR), (standard)
Finish	Viton (FPM), (for temperatures above 95°C) (203°F) Semi bright

**Noise**

One meter away from - and 1.6 meter above the exhaust the noise level of a valve actuator will be approximately 77db(A) without noise damper and approximately 72 db(A) with damper - Measured at 7 bars air-pressure.



It is important to observe the technical data during installation, operation and maintenance.  
 Inform the personnel about the technical data.  
 CPMI-2: Constant-Pressure Modulating Inlet.  
 CPMO-2: Constant-Pressure Modulating Outlet.

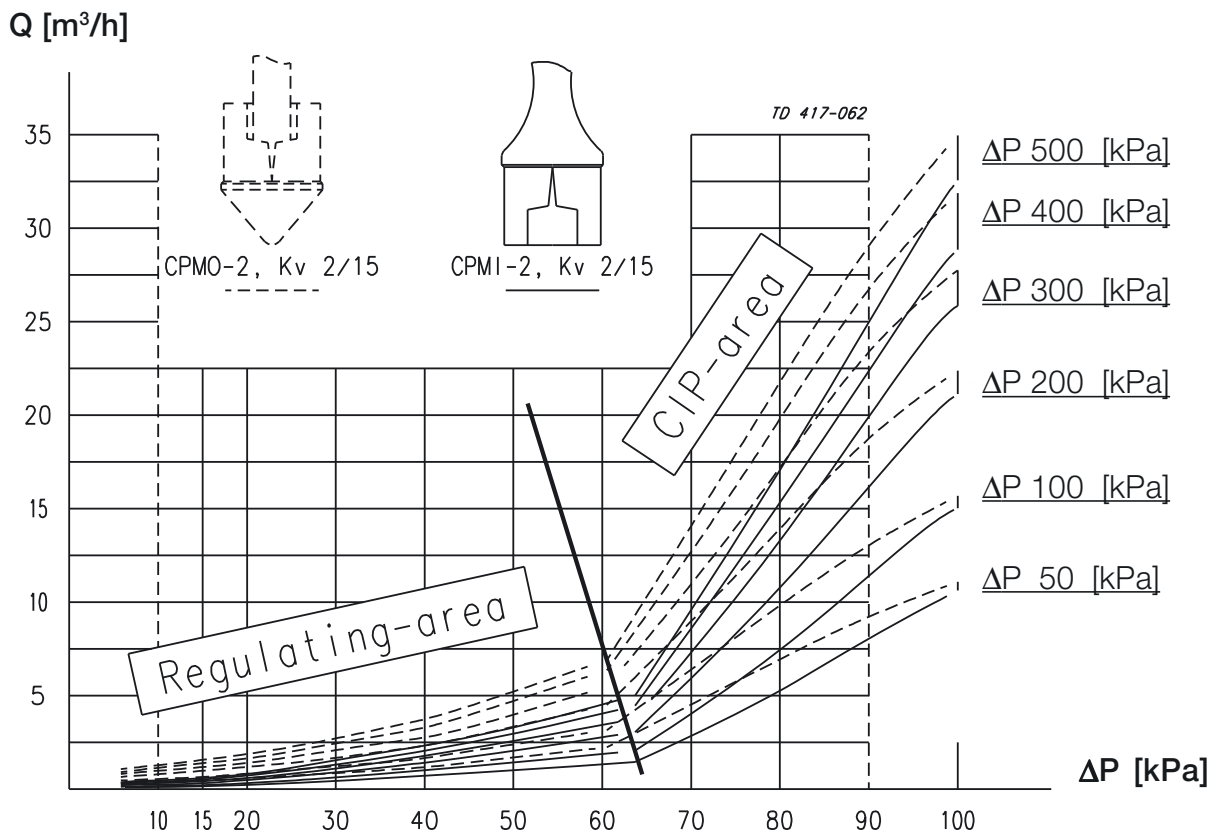
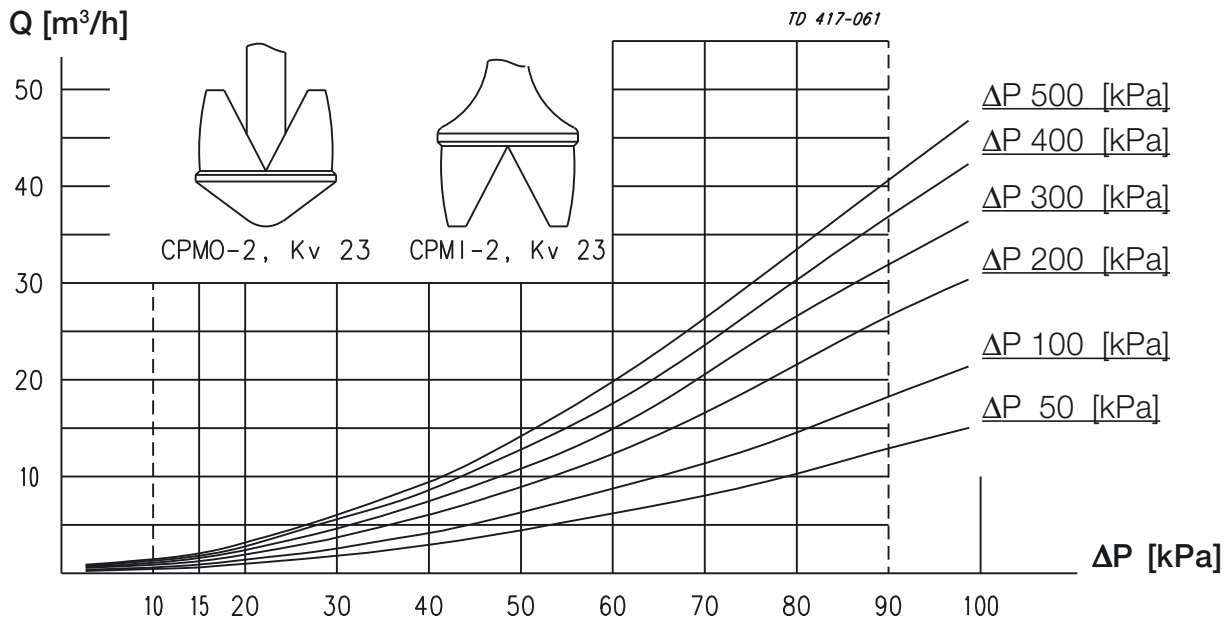

**NOTE!** For the diagrams the following applies:  
 Medium: Water (20°C) (68°F).  
 Measurement: In accordance with VDI 2173.

**Example 1:**

CPMI-2:  
 Pressure drop  $\Delta p = 200 \text{ kPa}$ . (29 psi)  
 Flow  $Q = 8 \text{ m}^3/\text{h}$ . (35 gal/min)  
 Select: CPMI-2, Kv 23 which at working point will be 48% open.

**Example 2:**

CPMI-2:  
 Pressure drop  $\Delta p = 300 \text{ kPa}$ . (43.5 psi)  
 Flow  $Q = 1 \text{ m}^3/\text{h}$ . (4.4 gal/m)  
 Select: CPMI-2, Kv 2/15 which at working point will be approx. 35% open equal to about 50% of the regulating area.

The drawing and the parts list include all items.

Parts list			Service Kits	
Item	Qty.	Denomination	Denomination	Item number
1	1	Nut	Product wetted parts	
2	1	Washer	NBR/EPDM-PTFE .....	9611-92-0218
3	1	Top	FPM/ PTFE .....	9611-92-0515
4	2	Washer	FPM/EPDM-PTFE .....	9611-92-0516
5	2	Screw	FPM/PTFE/EPDM-PTFE .....	9611-92-0517
6	2	Clamp		
7	1	Cover		
8 Δ	1	O-ring		
9	1	Guide		
10 Δ	1	Upper diaphragm		
11	2	Inner ring		
12	12	Support sector		
13	1	Outer ring		
14 Δ	1	Lower diaphragm		
15	1	Valve plug		
16	1	Valve body		

Δ: Service kits - product wetted parts

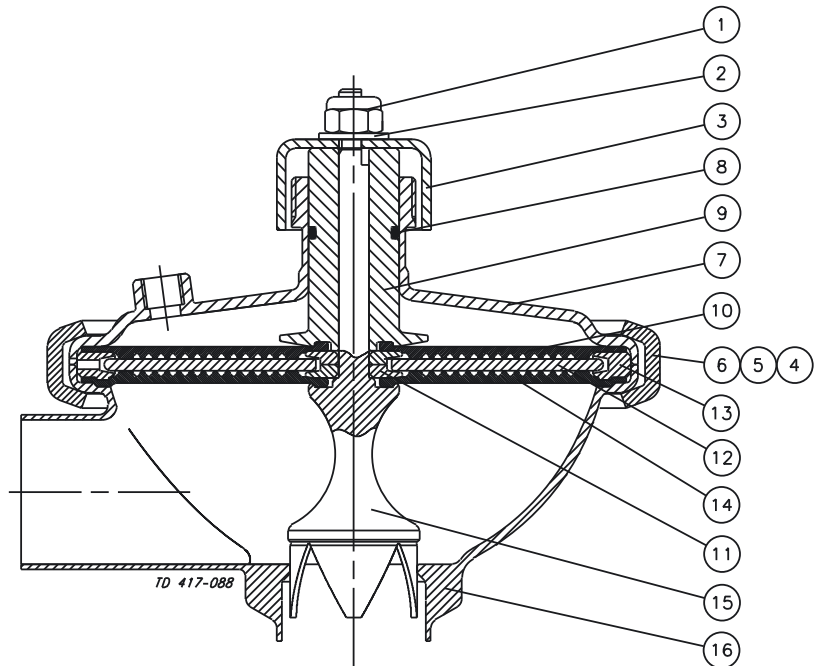
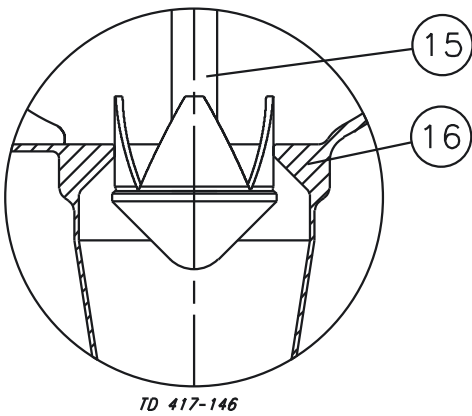

---

The drawing below shows CPM-2.  
CPMI-2: Constant-Pressure Modulating Inlet. CPMO-2: Constant-Pressure Modulating Outlet.  
The drawing includes all items of the valve. The items refer to the parts list on the opposite part of the page.

---

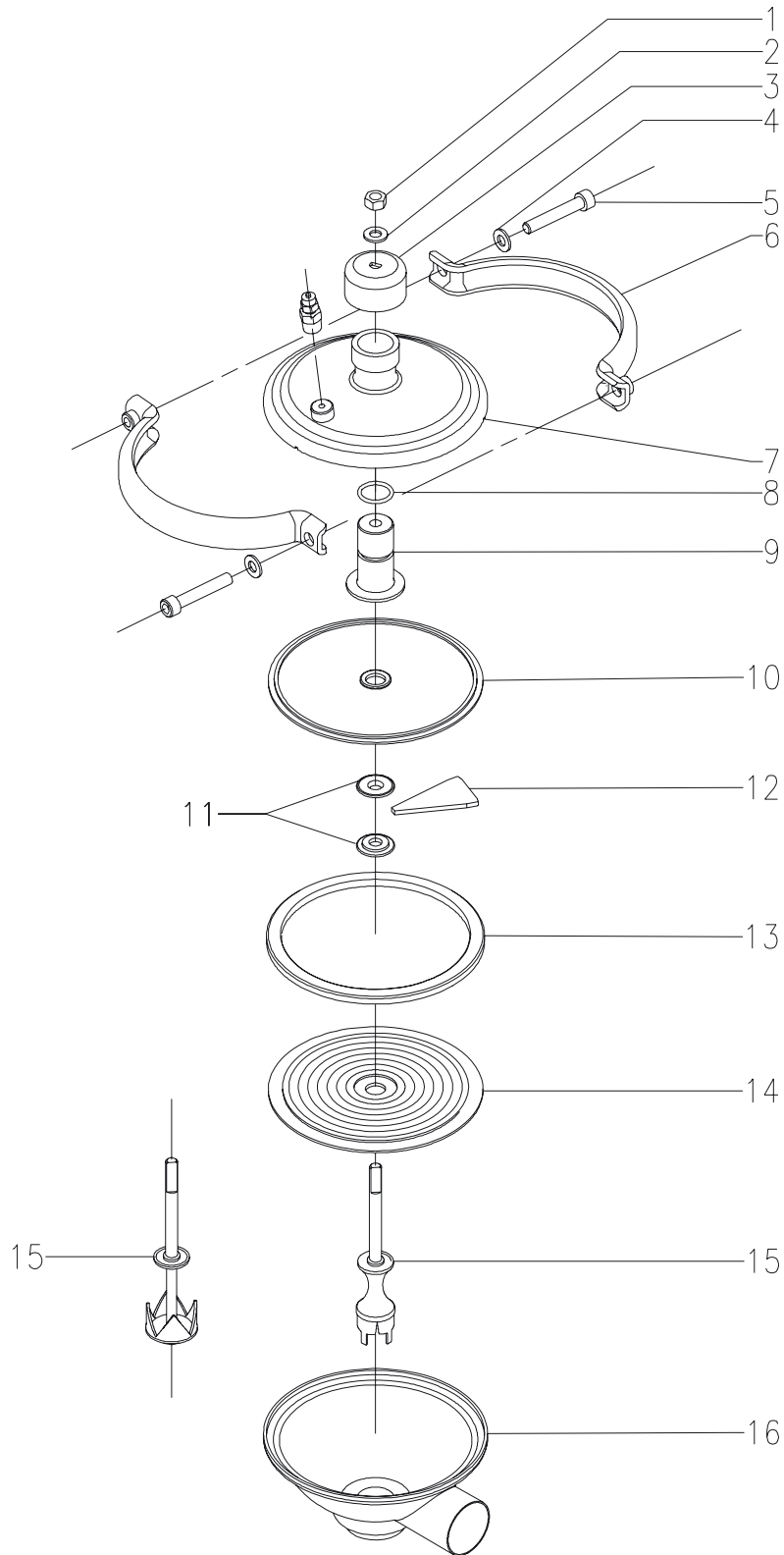

TD 417-144

The drawings and the parts list include all items.

Parts list			Service Kits	
Pos.	Qty.	Denomination	Denomination	Item number
1	1	Booster housing	Diaphragm .....	31356-0094-1
2	1	Lock nut		
3	1	Washer		
4	1	Spring washer		
5	1	Nut		
6	1	Booster piston		
7 Δ	1	Diaphragm		
8	1	Booster cover		
9	1	Clamps and screws		

Δ : Service kit

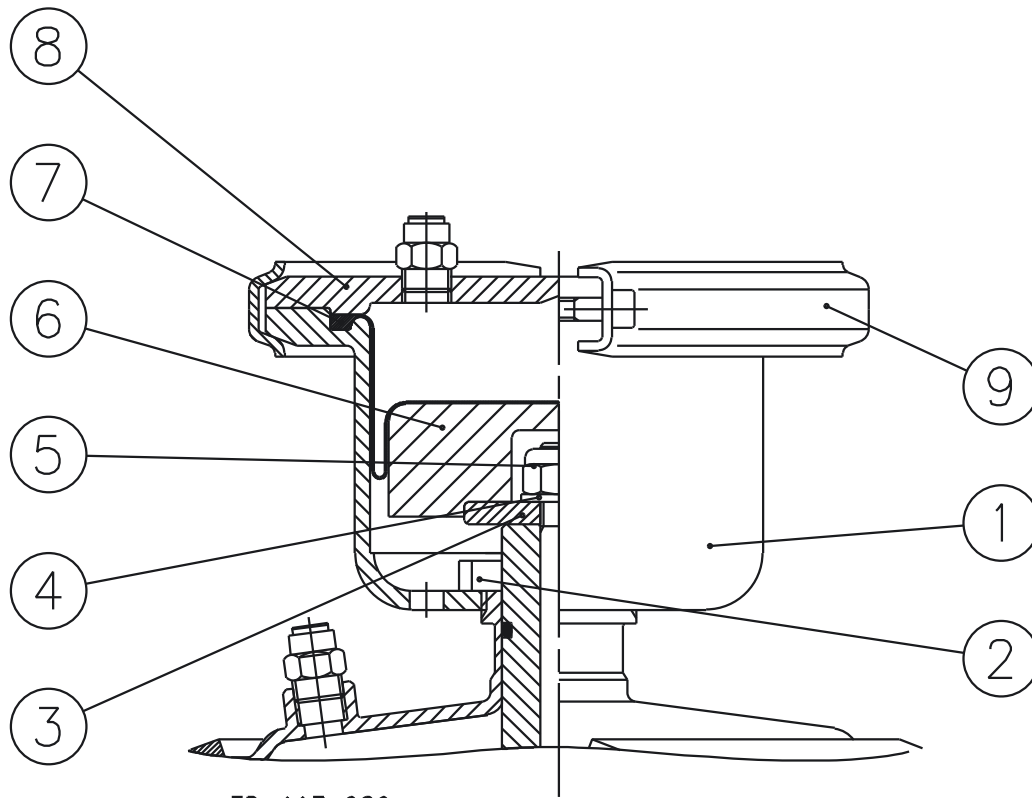

---

The drawing below shows the Booster.  
The items refer to the parts list on the opposite part of the page.  
The drawing includes all items of the valve.

---

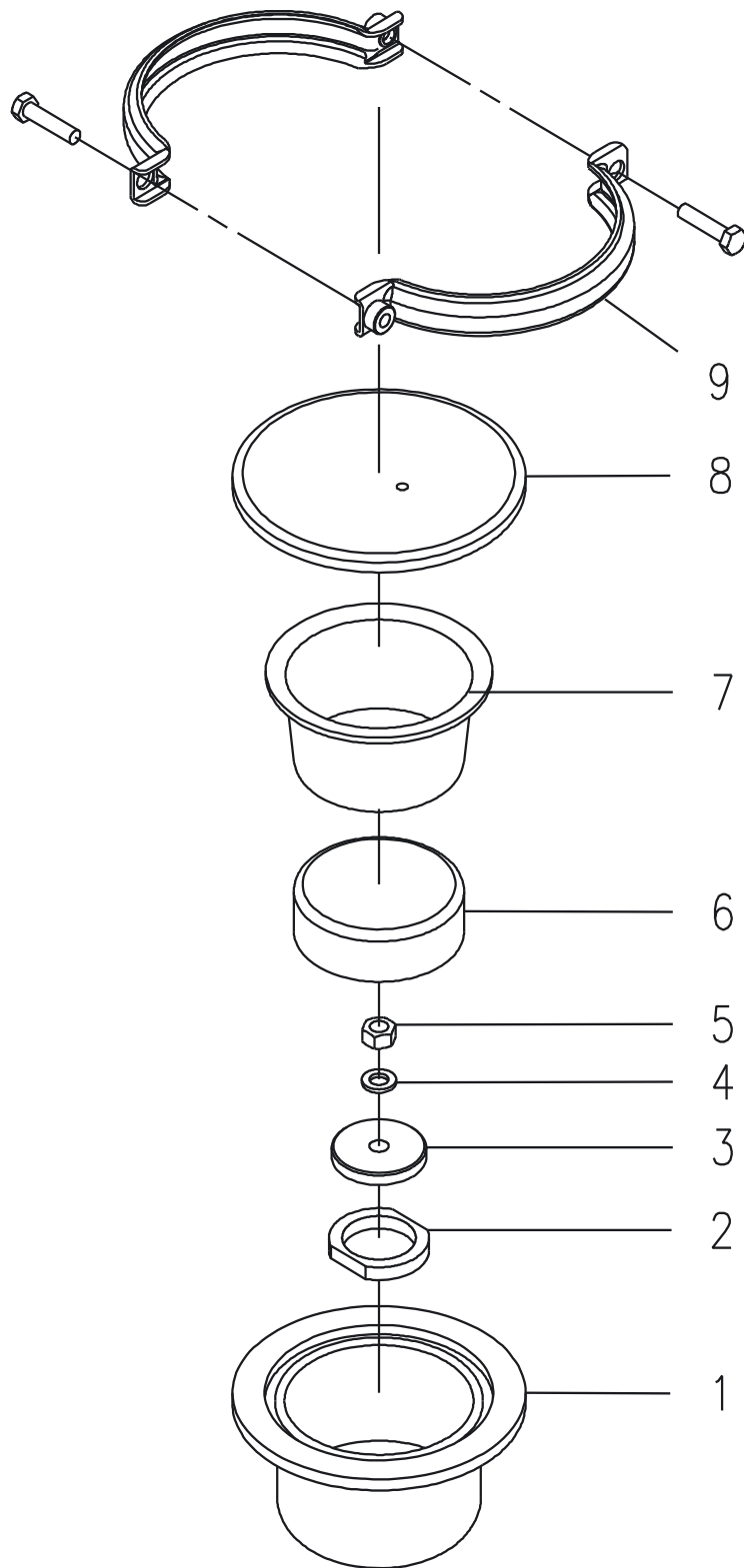

TD 417-145



---

**CSI**

417.831.1411  
[csidesigns.com](http://csidesigns.com)

---