

# Micro Motion® H-Series Hygienic Coriolis Flow and Density Meters

## High accuracy real world performance

- Best-in-class performance on liquid mass flow, volume flow and density measurements in a compact hygienic design
- Superior sensitivity in a compact design to reduce variability in process control
- Rugged design minimizing process, mounting, and environmental effects



## Best fit-for-application

- EHEDG certified, 3-A authorized, self-draining design for sanitary process control service
- Highly polished surface finish for ultra-pure fluids
- Broad range of I/O offerings including HART, Profibus-DP, FOUNDATION Fieldbus, DeviceNet, 4-20mA and Wireless capabilities

## Exceptional reliability and safety

- Smart Meter Verification delivers complete, on-line verification of device health and performance, continuously or on-demand at the press of a button
- Low operating frequency for robust measurement in continuous two-phase flow and gas applications
- Reliable sensor design minimizes down time and process interruption costs

ELITE

Peak performance

F-Series

Exceptional performance  
compact drainable

H-Series

Hygienic  
compact drainable

T-Series

Straight tube  
full bore

R-Series

General purpose  
flow and density

LF-Series

Extreme  
low flow



**CSI**

417.831.1411  
csidesigns.com

# Micro Motion® H-Series hygienic flow and density meters

Micro Motion H-Series meters deliver superb measurement with exceptional flow and density performance as well as outstanding reliability in a compact hygienic design for use in sanitary process control environments.

## Optimal flow and density fit for hygienic process control applications

- High performance rugged measurement in a compact self-draining design
- Low frequency, high sensitivity fit-and-forget meter provides robust measurements even under demanding process conditions
- Multiple line sizes provide an ideal platform for batching, distribution, allocation and intra-plant measurement applications

## Industry-leading capabilities that unleash your process potential

- Available with the most extensive offering of transmitter and mounting options for maximum compatibility with your system
- State of the art, ISO/IEC 17025 compliant calibration stands achieving  $\pm 0.014\%$  uncertainty drive best in class measurement accuracy
- The most robust communication protocol offering in the industry including Smart Wireless
- True multi-variable technology measures necessary flow and density process variables simultaneously

## Smart Meter Verification: advanced diagnostics for your entire system

- A comprehensive test that can be run locally or from the control room to provide confidence in your meter functionality and performance
- Verifies that your meter performs as well as the day it was installed, giving you assurance in less than 90 seconds
- Save significant expenditure by reducing labor and outsourced calibration service costs while eliminating process interruption

## Widest range of installation and process condition flexibility

- Featuring a low pressure drop, low weight design that reduces installation and commissioning costs
- Unmatched MVD transmitter technology with digital signal processing (DSP) delivers the fastest response rates enabling accurate batch and process measurement
- Design flexibility enables operation in SIP, CIP and sanitary where 3-A and EHEDG compliance is required

---

## Contents

Measurement principles .....	3	Meter approvals and certifications .....	9
Performance specifications .....	4	Transmitter interface .....	10
Operating conditions: Environmental .....	7	Physical specifications .....	10
Operating conditions: Process .....	8	Ordering information .....	13

## Measurement principles

As a practical application of the Coriolis effect, the Coriolis mass flow meter operating principle involves inducing a vibration of the flow tube through which the fluid passes. The vibration, though it is not completely circular, provides the rotating reference frame which gives rise to the Coriolis effect. While specific methods vary according to the design of the flow meter, sensors monitor and analyze changes in frequency, phase shift, and amplitude of the vibrating flow tubes. The changes observed represent the mass flow rate and density of the fluid.

### Mass flow measurement

The measuring tubes are forced to oscillate producing a sine wave. At zero flow, the two tubes vibrate in phase with each other. When flow is introduced, the Coriolis forces cause the tubes to twist resulting in a phase shift. The time difference between the waves is measured and is directly proportional to the mass flow rate.

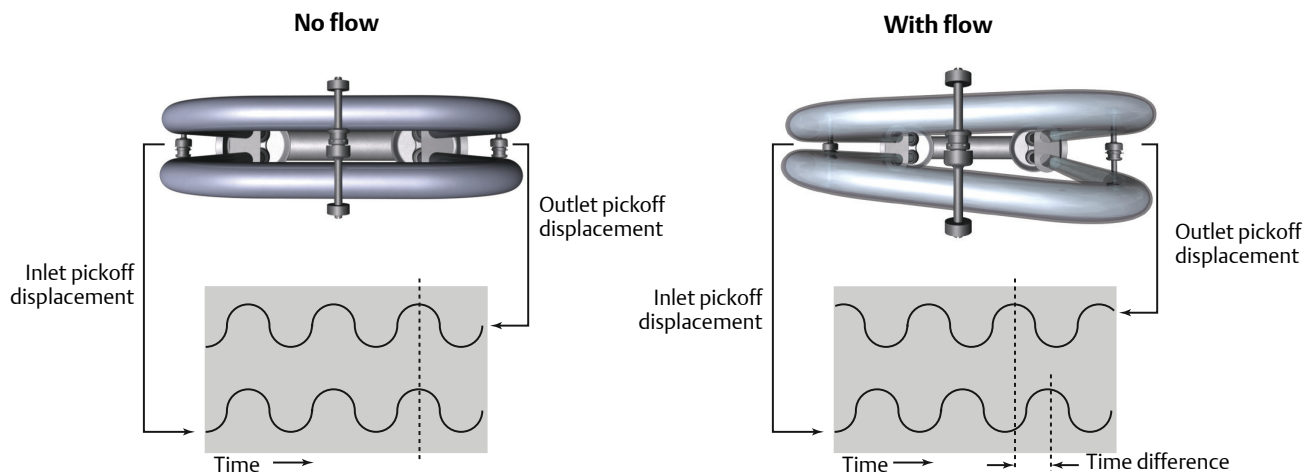

### Density measurement

The measuring tubes are vibrated at their natural frequency. A change in the mass of the fluid contained inside the tubes causes a corresponding change to the tube natural frequency. The frequency change of the tube is used to calculate density.

### Temperature measurement

Temperature is a measured variable that is available as an output. The temperature is also used internal to the sensor to compensate for temperature influences on Young's Modulus of Elasticity.

### Meter characteristics

- Measurement accuracy is a function of fluid mass flow rate independent of operating temperature, pressure, or composition. However, pressure drop through the sensor is dependent upon operating temperature, pressure, and fluid composition.
- Specifications and capabilities vary by model and certain models may have fewer available options. Please refer to the Online Store Sizing and Selection Tool at the Micro Motion web site ([www.micromotion.com/onlinestore](http://www.micromotion.com/onlinestore)) for detailed information regarding performance and capabilities.
- The letter at the end of the base model code (for example, H100S) represents wetted part material S = 316L stainless steel 32 Ra finish (0.8  $\mu\text{m}$ ) and F = 316L stainless steel 15 Ra finish (0.4  $\mu\text{m}$ ).

# Performance specifications

## Reference operating conditions

For determining the performance capabilities of our meters, the following conditions were observed/used:

- Water at 68 to 77 °F and 14.5 to 29 psig (20 to 25 °C and 1 to 2 barg)
- Accuracy based on industry leading accredited calibration stands according to ISO/IEC 17025
- All models have a density range up to 3 g/cm<sup>3</sup> (3000 kg/m<sup>3</sup>)

## Accuracy and repeatability on liquids and slurries

Performance Specifications	Calibration code Z	Calibration code 1	Calibration code K <sup>(1)(2)</sup>
Mass flow accuracy <sup>(3)</sup>	±0.15% of rate	±0.10% of rate	±0.10% of rate
Volume flow accuracy <sup>(1)</sup>	±0.15% of rate	±0.15% of rate	±0.10% of rate
Mass flow repeatability	±0.05% of rate		
Volume flow repeatability	±0.075% of rate	±0.075% of rate	±0.05% of rate
Density accuracy	±0.002 g/cm <sup>3</sup> (±2.0 kg/m <sup>3</sup> )	±0.001 g/cm <sup>3</sup> (±1.0 kg/m <sup>3</sup> )	±0.0005 g/cm <sup>3</sup> (±0.5 kg/m <sup>3</sup> )
Density repeatability	±0.001 g/cm <sup>3</sup> (±1.0 kg/m <sup>3</sup> )	±0.0005 kg/m <sup>3</sup> (±0.5 kg/m <sup>3</sup> )	±0.0002 kg/m <sup>3</sup> (±0.2 kg/m <sup>3</sup> )
Temperature accuracy	±1 °C ±0.5% of reading		
Temperature repeatability	±0.2 °C		

(1) Only available with electronics code 0, 1, 2, 3, 4, 5, 6, 7, 8, 9.

(2) Not available with model H025.

(3) Stated flow accuracy includes the combined effects of repeatability, linearity, and hysteresis.

## Accuracy and repeatability on gases

Performance specification	All models
Mass flow accuracy <sup>(1)</sup>	±0.50% of rate
Mass flow repeatability <sup>(1)</sup>	±0.25% of rate
Temperature accuracy	±1 °C ±0.5% of reading
Temperature repeatability	±0.2 °C

(1) Stated flow accuracy includes the combined effects of repeatability, linearity, and hysteresis

## Liquid flow rates

### Nominal flow rate

Micro Motion has adopted the term nominal flow rate, which is the flow rate at which water at reference conditions causes approximately 14.5 psig (1 barg) of pressure drop across the meter.

### Mass flow rates for all models

Model	Nominal line size		Nominal flow rate		Maximum flow rate	
	inch	mm	lb/min	kg/h	lb/min	kg/h
H025	1/4" to 1/2"	DN6 to DN13	50	1336	100	2,720
H050	1/2" to 1"	DN13 to DN25	155	4226	300	8,160
H100	1" to 2"	DN25 to DN50	604	16440	1,200	32,650
H200F	2" to 3"	DN50 to DN80	1,917	52,160	2,350	63,960
H200S	2" to 3"	DN50 to DN80	1,917	52,160	3,200	87,100
H300	3" to 4"	DN80 to DN100	5,298	144,200	9,995	272,000

### Volume flow rates for all models

Model	Nominal flow rate			Maximum flow rate		
	gal/min	barrels/h	l/h	gal/min	barrels/h	l/h
H025	6	9	1,366	12	18	2,720
H050	19	27	4,226	36	52	8,160
H100	72	103	16,440	144	206	32,650
H200F	230	328	52,160	384	550	87,100
H200S	230	328	52,160	384	550	87,100
H300	635	907	144,200	1,200	1,720	272,000

### Gas flow rates

When selecting sensors for gas applications, pressure drop through the sensor is dependent upon operating temperature, pressure, and fluid composition. Therefore, when selecting a sensor for any particular gas application, it is highly recommended that each sensor be sized using the Online Store Sizing and Selection Tool at the Micro Motion web site ([www.micromotion.com/onlinestore](http://www.micromotion.com/onlinestore)).

The below table indicates flow rates that produce approximately 25psig (1.7barg) pressure drop on natural gas.

#### Gas flow rates for all models

Model	Mass		Volume	
	lb/min	kg/h	SCFM	Nm <sup>3</sup> /h
H025	17	468	388	659
H050	52	1,429	1,183	2,010
H100	200	5,452	4,514	7,670
H200	666	18,137	15,018	25,515
H300	1,745	47,505	39,334	66,829

#### Notes

- Standard (SCFM) reference conditions are 14.7 psig and 60°F. Normal reference conditions are 1.013 barg and 0°C.
- Natural gas with molecular weight of 16.799 at 60°F (16°C) and 1014.7 psia (70 bara).

### Zero stability

Zero stability is used when the flow rate approaches the low end of the flow range where the meter accuracy begins to deviate from the stated accuracy rating, as depicted in the turndown section below. When operating at flow rates where meter accuracy begins to deviate from the stated accuracy rating, accuracy is governed by the formula: accuracy = (zero stability/flow rate) x 100%. Repeatability is similarly affected by low flow conditions.

#### Turndown capabilities

The graph and table below represent an example of the measurement characteristics under various flow conditions. At flow rates requiring large turndowns (greater than 20:1), the zero stability values may begin to govern capability dependent upon flow conditions and meter in use.

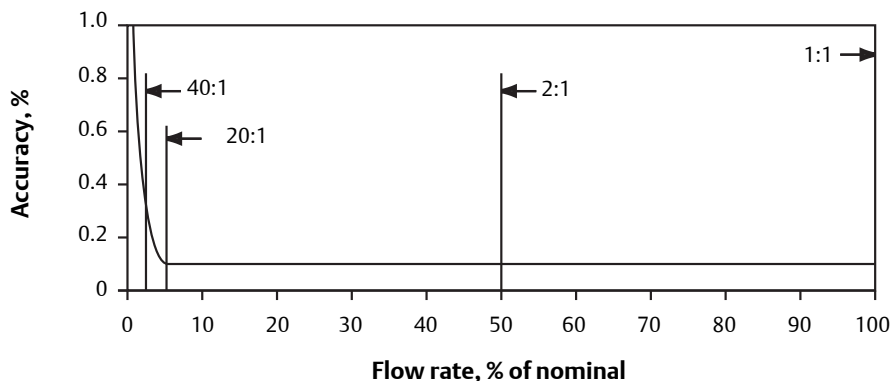

Turndown from nominal flow rate		40:1	15:1	2:1
Accuracy	±%	0.26	0.10	0.10
Pressure drop	psig (barg)	0.1 (0.01)	0.45 (0.03)	14.2 (0.98)

### Zero stability for all models

Model	Zero stability	
	lb/min	kg/h
H025	0.002	0.05
H050	0.012	0.32
H100	0.05	1.36
H200	0.16	4.35
H300	0.5	13.6

### Process pressure ratings

Sensor maximum working pressure reflects the highest possible pressure rating for a given sensor. Process connection type and environmental and process fluid temperatures may reduce the maximum rating. Refer to the Technical Data Sheet for common sensor and fitting combinations.

All sensors comply with ASME B31.3 process piping code and Council Directive 97/23/EC of 29 May 1997 on pressure equipment.

### Sensor maximum working pressure for all models

Model	psig	barg
H025F, H050F, H100F, H200F, H300F	1,015	70
H025S, H050S, H100S, H200S, H300S	1,450	100

### Case pressure

#### Case pressure for all models

Model	Case maximum pressure		NAMUR NE132		Typical burst pressure	
	psig	barg	psig	barg	psig	barg
H025	166	11	1,256	87	1,884	130
H050	135	9	1,020	70	1,530	105
H100	109	7	854	59	1,281	88
H200	64	4	507	35	760	52
H300	256	17	1,754	120	2,630	180

## Operating conditions: Environmental

### Vibration limits

Meets IEC 68.2.6, endurance sweep, 5 to 2000 Hz, 50 sweep cycles at 1.0g.

### Temperature limits

Sensors can be used in the process and ambient temperature ranges shown in the temperature limit graphs. For the purposes of selecting electronics options, temperature limit graphs should be used only as a general guide. If your process conditions are close to the gray area, consult with your Micro Motion representative.

**Notes**

- In all cases, the electronics cannot be operated where the ambient temperature is below -40°F (-40°C) or above +140°F (+60°C). If a sensor is to be used where the ambient temperature is outside of the range permissible for the electronics, the electronics must be remotely located where the ambient temperature is within the permissible range, as indicated by the shaded areas of the temperature limit graphs.
- Temperature limits may be further restricted by hazardous area approvals. Refer to the hazardous area approvals documentation shipped with the sensor or available from the Micro Motion web site ([www.micromotion.com](http://www.micromotion.com)).
- The extended-mount electronics option allows the sensor case to be insulated without covering the transmitter, core processor, or junction box, but does not affect temperature ratings. When insulating the sensor case at elevated process temperatures (above 140°F), please ensure electronics are not enclosed in insulation as this may lead to electronics failure.

**Ambient and process temperature limits for all H-Series meters**

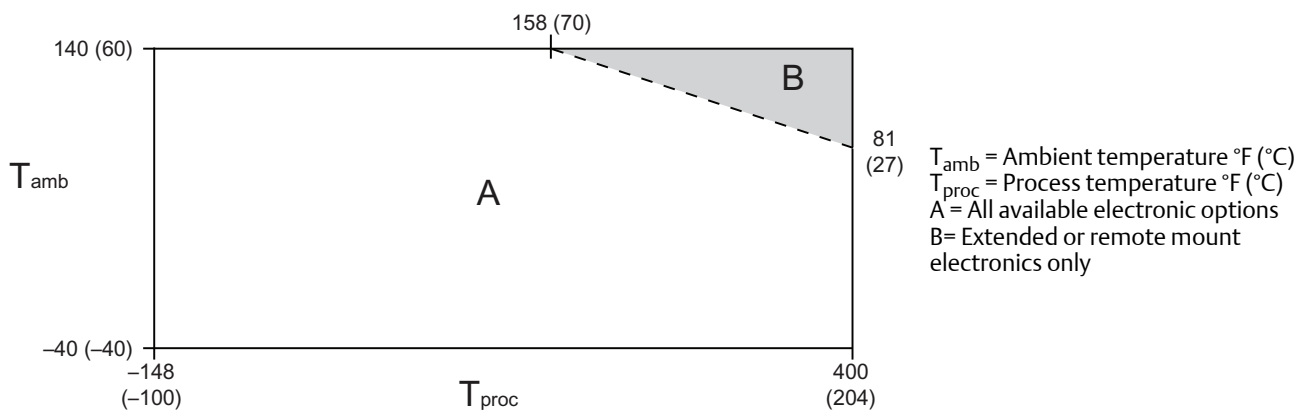

## Operating conditions: Process

### Process temperature effect

- For mass flow measurement, process temperature effect is defined as the change in sensor flow accuracy due to process temperature change away from the calibration temperature. Temperature effect can be corrected by zeroing at the process conditions.
- For density measurement, process temperature effect is defined as the change in sensor density accuracy due to process temperature change away from the calibration density. See installation manual for proper setup and configuration.

Process temperature effect

Model code	Mass flow rate (% of maximum rate) per °C	Density	
		g/cm <sup>3</sup> per °C	kg/m <sup>3</sup> per °C
H025, H050, H100, H200, H300	±0.0007	±0.0001	±0.1

### Process pressure effect

Process pressure effect is defined as the change in sensor flow and density accuracy due to process pressure change away from the calibration pressure. This effect can be corrected by dynamic pressure input or a fixed meter factor. See installation manual for proper setup and configuration.







**Process pressure effect for all models**

Model code	Liquid or gas flow (% of rate)		Density	
	per psig	per barg	g/cm <sup>3</sup> per psig	kg/m <sup>3</sup> per barg
H025, H050, H100	none	none	none	none
H200, H300	-0.001	-0.015	-0.00003	-0.43

## Meter approvals and certifications

**Approvals and certifications**

Type	Approval or certification (typical)	
CSA and CSA C-US	Ambient temperature: -40 to +140 °F (-40 to +60 °C) Class I, Div. 2, Groups A, B, C, and D Class II, Div.2, Groups F and G	
ATEX	 	II 3G Ex nA IIC T1-T5 Gc II 3D Ex tc IIIC T(1) °C Dc IP66
	 0575 	II 2 G Ex ib IIB/IIC T1-T4/T5/T6 Gb II 2 D Ex ib IIIC T*°C Db IP65 NOTE: the H300 is Ex ib IIB; only with approval option code 6 it is Ex ib IIC.
IECEX	Ex nA IIC T1-T5 Gc	
	Ex ib IIB/IIC T1-T4/T5/T6 Gb. NOTE: the H300 is Ex ib IIB; only with approval option code 7 it is Ex ib IIC.	
Ingress Protection Rating	IP 66/67 for sensors and transmitters	
EMC effects	Complies with EMC directive 2004/108/EC per EN 61326 Industrial	
	Complies with NAMUR NE-21 (09.05.2012)	

**Notes**

- Approvals shown are for H-Series meters configured with a model 2400S transmitter. Meters with integral electronics may have more restrictive approvals. Refer to the Product Data Sheet for each transmitter for details.
- When a meter is ordered with hazardous area approvals, detailed information is shipped along with the product.
- More information about hazardous approvals, including detailed specifications and temperature graphs for all meter configurations is available on the H-Series product page at the Micro Motion web site ([www.micromotion.com](http://www.micromotion.com)).

**Industry standards**

Type	Standard
Weights and Measures for custody transfer applications:	<ul style="list-style-type: none"> <li>■ National Type Evaluation Program (NTEP)</li> <li>■ Measurement Canada</li> </ul>
Industry standards and commercial approvals	<ul style="list-style-type: none"> <li>■ NAMUR: NE132 (burst pressure, sensor flange to flange length), NE131</li> <li>■ Pressure Equipment Directive (PED)</li> <li>■ Canadian Registration Number (CRN)</li> <li>■ Dual Seal</li> <li>■ ASME B31.3 Piping Code</li> <li>■ SIL2 and SIL3 safety certifications</li> </ul>
Hygienic approvals	<ul style="list-style-type: none"> <li>■ ASME BPE</li> <li>■ EHEDG, 3A</li> </ul>

## Transmitter interface

A Micro Motion flowmeter system is highly customizable to provide a configuration that is tailor-fit to specific applications.

Robust transmitter offerings allow a multitude of mounting options:

- Compact mounting integral to the sensor
- Field mount variants for harsh conditions
- Compact control room DIN rail packages for optimal locating in a control cabinet
- Specific fit-for-purpose solutions for two-wire connectivity or filling and dosing machinery integration

H-Series meters are available with an expansive selection of input and output connectivity options including the following:

- 4-20 mA
- HART™
- WirelessHART™
- EtherNet/IP
- FOUNDATION™ fieldbus
- PROFIBUS
- Modbus®
- Other protocols may be available on request

## Physical specifications

### Materials of construction

General corrosion guidelines do not account for cyclical stress, and therefore should not be relied upon when choosing a wetted material for your Micro Motion meter. Please refer to the *Micro Motion Corrosion Guide* for material compatibility information.

## Wetted part materials

Model	All models 316L stainless steel	Sensor weight	
		lb	kg
H025	•	13	6
H050	•	15	7
H100	•	23	11
H200	•	42	19
H300	•	136	62

### Notes

- Weight specifications are based upon ASME B16.5 CL150 flange and do not include electronics.
- Heat jackets and steam kits are also available.

## Non-wetted part materials

Component	Enclosure rating	316L/CF-3M stainless steel	304L stainless steel	Polyurethane-painted aluminum
Sensor housing	—		•	
Core processor housing	NEMA 4X (IP66/67)	•		•
Junction box housing	NEMA 4X (IP66)	•		•
Model 1700/2700 transmitter housing	NEMA 4X (IP66)	•		•
Model 3700 transmitter housing	NEMA 4X (IP66/67)			•
Model 2400S transmitter housing	NEMA 4X (IP66/67)	•		•
Model 2200S transmitter housing	NEMA 4X (IP66/67)	•		•

## Flanges

Sensor type	Flange types
All sensor models	<ul style="list-style-type: none"> <li>■ DIN11851, DIN11864-1A, DIN11864-2A (up to DN80)</li> <li>■ IDF (Up to 3s)</li> <li>■ ISO 2853 (IDF) (DN76.1)</li> <li>■ Hygienic tri-clamp compatible</li> </ul>

### Note

For flange compatibility, please refer to the Online Store Sizing and Selection Tool at the Micro Motion web site ([www.micromotion.com](http://www.micromotion.com)).

## Dimensions

These dimensional drawings are intended to provide a basic guideline for sizing and planning. They are representative of a sensor fitted with a Tri-clamp compatible flange and 2400 transmitter.

Face-to-Face (Dim. A, below) dimensions for all H-Series meters with each available process connection can be found in the H-series Technical Data Sheet.

Complete and detailed dimensional drawings can be found through the product link in our online store ([www.micromotion.com/onlinestore](http://www.micromotion.com/onlinestore)).

**Note:**

- All dimensions  $\pm 1/8$  inch ( $\pm 3$  mm)
- Representative of a sensor fitted with a Tri-clamp compatible flange and 2400 transmitter

**Example dimensions for all models**

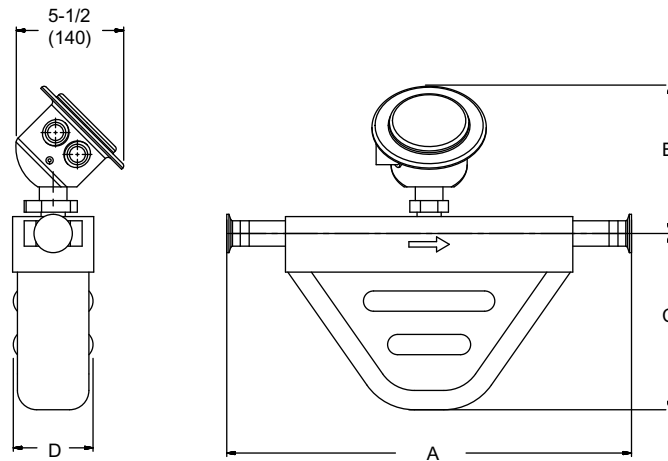

Model	Dim. A		Dim. B		Dim. C		Dim. D	
	Inch	mm	Inch	mm	Inch	mm	Inch	mm
H025	15-15/16	405	7-3/8	187	5-1/8	130	2-13/16	71
H050	17-7/16	443	7-3/8	187	6-3/4	171	2-15/16	75
H100	20-15/16	532	7-5/8	194	9-1/8	232	4-1/8	105
H200	21-1/4	540	8-9/16	217	12-9/16	319	5-5/8	143
H300	35-1/8	892	10-5/16	262	7-1/4	184	5-7/8	149

# Ordering information

## Product code structure

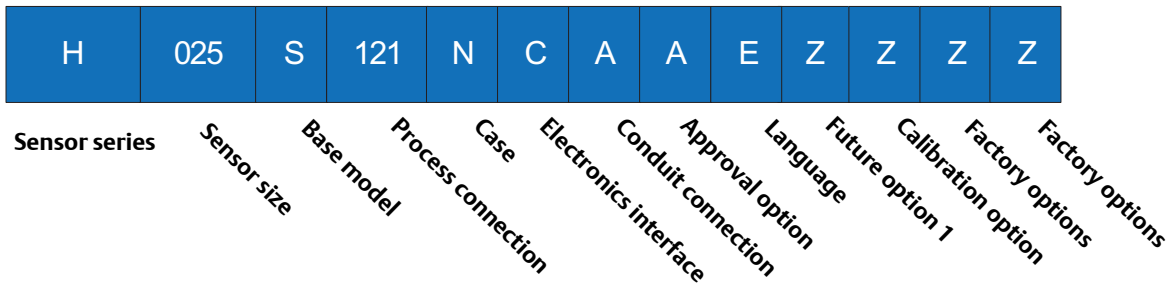

## Sensor size and base model

Codes S and F are model designations used to identify the type of meter.

Model	Material		
S	316L stainless steel; 32 Ra finish (0.8 μm)		
F	316L stainless steel; 15 Ra finish (0.4 μm)	F	S
		H025 1/4-inch (DN6)	F S
		H050 1/2-inch (DN15)	F S
		H100 1-inch (DN25)	F S
		H200 2-inch (DN50)	F S
		H300 3-inch (DN80)	F S

## Process connections

### Model H025

Code	Description				
121	1/2-inch	Tri-Clamp compatible	316L	Hygienic fitting	
222	DN15	DIN11851	316L	Hygienic coupling	
665	8A	IDF	316L	Hygienic fitting	Type CLF W
676	DN15	DIN11864-1A	316L	Aseptic connection	

### Model H050

Code	Description				
222	DN15	DIN11851	316L	Hygienic coupling	
322	3/4-inch	Tri-Clamp compatible	316L	Hygienic fitting	
667	15A	IDF	316L	Hygienic fitting	Type CLF W
676	DN15	DIN11864-1A	316L	Aseptic connection	

### Model H100

Code	Description				
138	1-inch	Tri-Clamp compatible	316L	Hygienic fitting	
230	DN25	DIN11851	316L	Hygienic coupling	
668	1s	IDF	316L	Hygienic fitting	Type CLF2 W
677	DN25	DIN11864-1A	316L	Aseptic connection	

### Model H200

Code	Description				
352	2-inch	Tri-Clamp compatible	316L	Hygienic fitting	
354	DN50	DIN11851	316L	Hygienic coupling	
669	2s	IDF	316L	Hygienic fitting	Type CLF2 W
678	DN50	DIN11864-1A	316L	Aseptic connection	

### Model H300

Code	Description				
361	3-inch	Tri-Clamp compatible	316L	Hygienic fitting	
664	DN76.1	ISO 2853 (IDF)	316L	Hygienic coupling	
679	DN80	DIN11864-1A	316L	Aseptic connection	
680	DN80	DIN11864-2A	316L	Aseptic connection	
685	DN80	DIN11851	316L	Hygienic coupling	
687	3s	IDF	316L	Hygienic fitting	Type CLF2 W
694	DN76	SMS 1145	316L	Hygienic coupling	

### Case options (Models H015, H100, H200)

Code	Case option
N	Standard case
P	Standard case with purge fittings (1/2 inch NPT female)

### Case options (Model H300 only)

Code	Case option
N	Standard case
B	Secondary containment with test report
P	Secondary containment with test report and purge fittings (1/2-inch NPT female)

### Electronics interface

Code	Description	Availability
0	For integral mount Model 2400S transmitter	
1	For extended mount Model 2400S transmitter	
2	4-wire polyurethane-painted aluminum integral enhanced core processor for remote mount transmitters	
3 <sup>(1)</sup>	4-wire stainless steel integral enhanced core processor for remote mount transmitters	
4	4-wire polyurethane-painted aluminum integral extended mount enhanced core processor for remote mount transmitters	
5 <sup>(1)</sup>	4-wire extended mount stainless steel integral enhanced core processor for remote mount transmitters	
6 <sup>(2)</sup>	MVDSolo; polyurethane-painted aluminum integral enhanced core processor (for OEMs)	
7 <sup>(1)(2)</sup>	MVDSolo; stainless steel integral enhanced core processor (for OEMs)	
8 <sup>(2)</sup>	MVDSolo; extended mount polyurethane-painted aluminum integral enhanced core processor (for OEMs)	
9 <sup>(1)(2)</sup>	MVDSolo; extended mount stainless steel enhanced core processor (for OEMs)	
Q	4-wire polyurethane-painted aluminum integral core processor for remotely mounted transmitters	
A	4-wire stainless steel integral core processor for remotely mounted transmitters	
V	4-wire extended mount polyurethane-painted aluminum integral core processor for remote mount transmitters	
B	4-wire extended mount stainless steel integral core processor for remote mount transmitters	
C	For integral mount 1700/2700 transmitter	
L <sup>(3)</sup>	For integral mount standard finish FMT transmitter	
K <sup>(3)</sup>	For integral mount improved-surface finish (64 Ra [1.6 μm]) FMT transmitter	
W <sup>(1)</sup>	MVDSolo; polyurethane-painted aluminum integral core processor for direct host connection (for OEMs)	
D <sup>(1)</sup>	MVDSolo; stainless steel integral core processor for direct host connection (for OEMs)	
Y <sup>(1)</sup>	MVDSolo; extended mount polyurethane-painted aluminum integral core processor (for OEMs)	
E <sup>(1)</sup>	MVDSolo; extended mount stainless steel integral core processor (for OEMs)	
R	9-wire polyurethane-painted aluminum junction box	
H	9-wire extended mount polyurethane-painted aluminum junction box with	
H025, H050, H100		H R E Y D W K L U B V A Q 9 8 7 6 5 4 3 2 1 0
H200, H300		H R E Y D W U B V A Q 9 8 7 6 5 4 3 2 1 0

(1) Not available for truck mount.  
 (2) When electronics interface W, D, Y, E, 6, 7, 8 or 9 is ordered with approval C, A, I, or Z, MVD Direct Connect™ I.S. barrier is supplied.  
 (3) Must be ordered with transmitter; only available with case code N.

### Conduit connections

Code	Description	Availability												
A	M20 – no gland													
B <sup>(1)</sup>	1/2-inch NPT – no gland													
E	M20 – no gland; not available with electronics interface code Q, A, V, or B in combination with approval code T or S on models H200S-H300S													
F <sup>(1)</sup>	Brass/nickel cable gland (cable diameter 0.335 to 0.394 inches [8.5 to 10 mm])													
G <sup>(1)</sup>	Stainless steel cable gland (cable diameter 0.335 to 0.394 inches [8.5 to 10 mm])													
H <sup>(1)</sup>	Brass/nickel cable gland													
J <sup>(1)</sup>	Stainless steel cable gland													
K <sup>(2)</sup>	JIS B0202 1/2G - no gland													
L <sup>(2)</sup>	Japan - brass nickel gland													
M <sup>(2)</sup>	Japan - stainless cable gland													
N <sup>(2)</sup>	JIS B0202 3/4G - no gland													
O <sup>(2)</sup>	Japan - brass nickel gland													
P <sup>(2)</sup>	Japan - stainless cable gland													
All models with electronics interface codes 0, 1, C, K, and L														
All models with electronics interface codes 2, 3, 4, 5, Q, A, V, and B														
All models with electronics interface codes 6, 7, 8, 9, W, D, Y, and E														
All models with electronics interface codes R and H														
		P	O	N	M	L	K	J	H	G	F	E	B	A
														A
						M	L	K			G	F	E	B
											G	F	E	B
		P	O	N				J	H					A

(1) Not available with approval T, S or J on models H200S and H300S.

(2) Only available with approval code M, T, or S.

### Approval options

Code	Description	Availability												
A	CSA (US and Canada): Class 1, Division 1, Groups C and D													
C	CSA (Canada only)													
G	Country Specific Approval – Requires a selection from the Approvals section of the ‘Certificate, Tests, Calibrations and Services’ model code option													
I	IECEX Zone 1													
J	Hardware ready for TIIS approval; EPM Japan only; requires conduit connection code E when used with electronics code Q, A, V, or B; requires conduit code A when used with electronics code R or H.													
M	Micro Motion Standard; no approval; no barrier included													
N	Micro Motion Standard / PED compliant; no approval; no barrier included													
S	TIIS – T3 Temperature Classification; not available for quote outside of Japan													
T	TIIS - T4 Temperature Classification; not available for quote outside of Japan													
V	ATEX - Equipment Category 3 (Zone 2) / PED compliant													
Z	ATEX - Equipment Category 2 (Zone 1) / PED compliant													
2	CSA (US and Canada): Class 1, Division 2, Groups A,B,C,D													
3	IECEX Zone 2													
All models with electronics code 0, 1, L, and K														
All models with electronics code Q, A, V, B, C, R, and H														
All models with electronics code 6, 7, 8, 9, W, D, Y, and E														
All models with electronics code 2, 3, 4, and 5														
		3	2	Z	V	T	S	N	M	J	I	G	C	A
		3	2		V			N	M			G		
				Z		T	S	N	M	J	I	G	C	A
				Z				N	M		I	G	C	A
				Z				N	M		I	G		A



## Languages

Code	Language option
A	Danish CE requirements document and English installation manual
C	Czech installation manual
D	Dutch CE requirements document and English installation manual
E	English installation manual
F	French installation manual
G	German installation manual
H	Finnish CE requirements document and English installation manual
I	Italian installation manual
J	Japanese installation manual
M	Chinese installation manual
N	Norwegian CE requirements document and English installation manual
O	Polish installation manual
P	Portuguese installation manual
S	Spanish installation manual
W	Swedish CE requirements document and English installation manual
B	Hungarian CE requirements document and English installation manual
K	Slovak CE requirements document and English installation manual
T	Estonian CE requirements document and English installation manual
U	Greek CE requirements document and English installation manual
L	Latvian CE requirements document and English installation manual
V	Lithuanian CE requirements document and English installation manual
Y	Slovenian CE requirements document and English installation manual

## Future option 1

Code	Future option 1
Z	For models H025F, H050F, H100F, H200F, H300F; reserved for future use

## Calibration

Code	Calibration option
Z	0.15% mass flow, 0.25% volume flow, and 0.002 g/cm <sup>3</sup> density calibration
1	0.10% mass flow, 0.15% volume flow, and 0.001 g/cm <sup>3</sup> density calibration
K	0.10% mass flow, 0.15% volume flow, and 0.0005 g/cm <sup>3</sup> (0.5 kg/m <sup>3</sup> ) density calibration <sup>(1)(2)</sup>

(1) Only available with electronics code 0, 1, 2, 3, 4, 5, 6, 7, 8, 9.

(2) Not available with model H025.

## Factory options

Code	Factory options
Z	No measurement application software

## Factory options

Code	Factory option
Z	Standard product
X	ETO product
R	Restocked product if available

## Certificates, tests, calibrations, and services

These option codes can be added to the end of the model code if needed, but no code is required when none of these options is selected.

### Note

There may be additional options or limitations depending on total meter configuration. Contact a sales representative before making your final selections.

### Material quality examination tests and certificates

Select any from this group.

Code	Factory option
MC	Material inspection certificate 3.1 (supplier lot traceability per EN 10204)
NC	NACE certificate 2.1 (MR0175 and MR0103)

### Radiographic testing

Select only one from this group.

Code	Factory option
RE	X-ray package 3.1 (radiographic examination certificate; weld map; radiographic inspection NDE qualification)
RT	X-ray package 3.1 (radiographic examination certificate with digital image; weld map; radiographic inspection NDE qualification)

### Pressure testing

Code	Factory option
HT	Hydrostatic test certificate 3.1

### Dye penetrant examination

Code	Factory option
D1	Dye penetrant test package 3.1 (Liquid Dye Penetration NDE Qualification): <ul style="list-style-type: none"> <li>■ Sensor only (H025-H200)</li> <li>■ Sensor process connection only (H300)</li> </ul>

**Weld examination**

Code	Factory option
WP	Weld procedure package (weld map, weld procedure specification, weld procedure qualification record, welder performance qualification)

**Positive material testing**

Select only one from this group.

Code	Factory option
PM	Positive material test certificate 3.1 without carbon content
PC	Positive material test certificate 3.1 including carbon content

**Special cleaning**

Code	Factory option
O2	Declaration of compliance oxygen service 2.1

**GOST compliance**

Code	Factory option
GR	Russian GOST calibration verification certificate

**Accredited calibration**

Code	Factory option
IC	ISO17025 accredited calibration and certificates (9 points total)

**Special calibration options**

Select either none, CV, or CV with one of the additional verification point options.

**Note:**

For all special calibration options, the minimum flow rate for any verification point is 5% of sensor nominal flow rate.

Code	Factory option
CV	Custom verification (alter original verification points)
01	Add 1 additional verification point
02	Add 2 additional verification point
03	Add 3 additional verification point
06	Add up to 6 additional verification points
08	Add up to 8 additional verification points
16	Add up to 16 additional verification points

**Sensor completion options**

Select any from this group.

Code	Factory option
WG	Witness general
SP	Special packaging

**Country specific approvals**

Select one from the following if approval code G is selected.

Code	Factory option
R1	EAC Zone 1 – Hazardous Approval <sup>(1)(2)</sup>
R3	EAC Zone 2 – Hazardous Approval <sup>(1)(3)</sup>
B1	INMETRO Zone 1 – Hazardous Approval <sup>(1)(2)</sup>
B3	INMETRO Zone 2 – Hazardous Approval <sup>(1)(3)</sup>

- (1) Only available with approval code G.
- (2) Not available with electronics code 0, 1, K, or L.
- (3) Only available with electronics code 0, 1, K, and L.







**CSI**

417.831.1411  
csidesigns.com

### Emerson Process Management Americas

7070 Winchester Circle  
Boulder, Colorado USA 80301  
[www.MicroMotion.com](http://www.MicroMotion.com)  
[www.Rosemount.com](http://www.Rosemount.com)  
T: +1 800 522 6277  
T: +1 (303) 527 5200  
F: +1 (303) 530 8459

Mexico T: 52 55 5809 5300  
Argentina T: 54 11 4837 7000  
Brazil T: 55 15 3413 8000  
Venezuela T: 58 26 1300 8100  
Chile T: 56 2 2928 4800

### Emerson Process Management Europe/Middle East

Central & Eastern Europe T: +41 41 7686 111  
Dubai T: +971 4 811 8100  
Abu Dhabi T: +971 2 697 2000  
France T: 0800 917 901  
Germany T: 0800 182 5347  
Italy T: 8008 77334  
The Netherlands T: +31 (0) 70 413 6666  
Belgium T: +32 2 716 77 11  
Spain T: +34 913 586 000  
U.K. T: 0870 240 1978  
Russia/CIS T: +7 495 981 9811

### Emerson Process Management Asia Pacific

Australia T: (61) 3 9721 0200  
China T: (86) 21 2892 9000  
India T: (91) 22 6662 0566  
Japan T: (81) 3 5769 6803  
South Korea T: (82) 2 3438 4600  
Singapore T: (65) 6 777 8211

© 2016 Micro Motion, Inc. All rights reserved.

The Emerson logo is a trademark and service mark of Emerson Electric Co. Micro Motion, ELITE, ProLink, MVD and MVD Direct Connect marks are marks of one of the Emerson Process Management family of companies. All other marks are property of their respective owners.

Micro Motion supplies this publication for informational purposes only. While every effort has been made to ensure accuracy, this publication is not intended to make performance claims or process recommendations. Micro Motion does not warrant, guarantee, or assume any legal liability for the accuracy, completeness, timeliness, reliability, or usefulness of any information, product, or process described herein. We reserve the right to modify or improve the designs or specifications of our products at any time without notice. For actual product information and recommendations, please contact your local Micro Motion representative.